

LG-ITR2C-502725-3.1

DATA SHEET

SPEC.NO.: SZ18080411
DATE: 2021/02/20
REV. A/4

Approved By:

Checked By:

Prepared By:

LIGHT

Package Dimensions

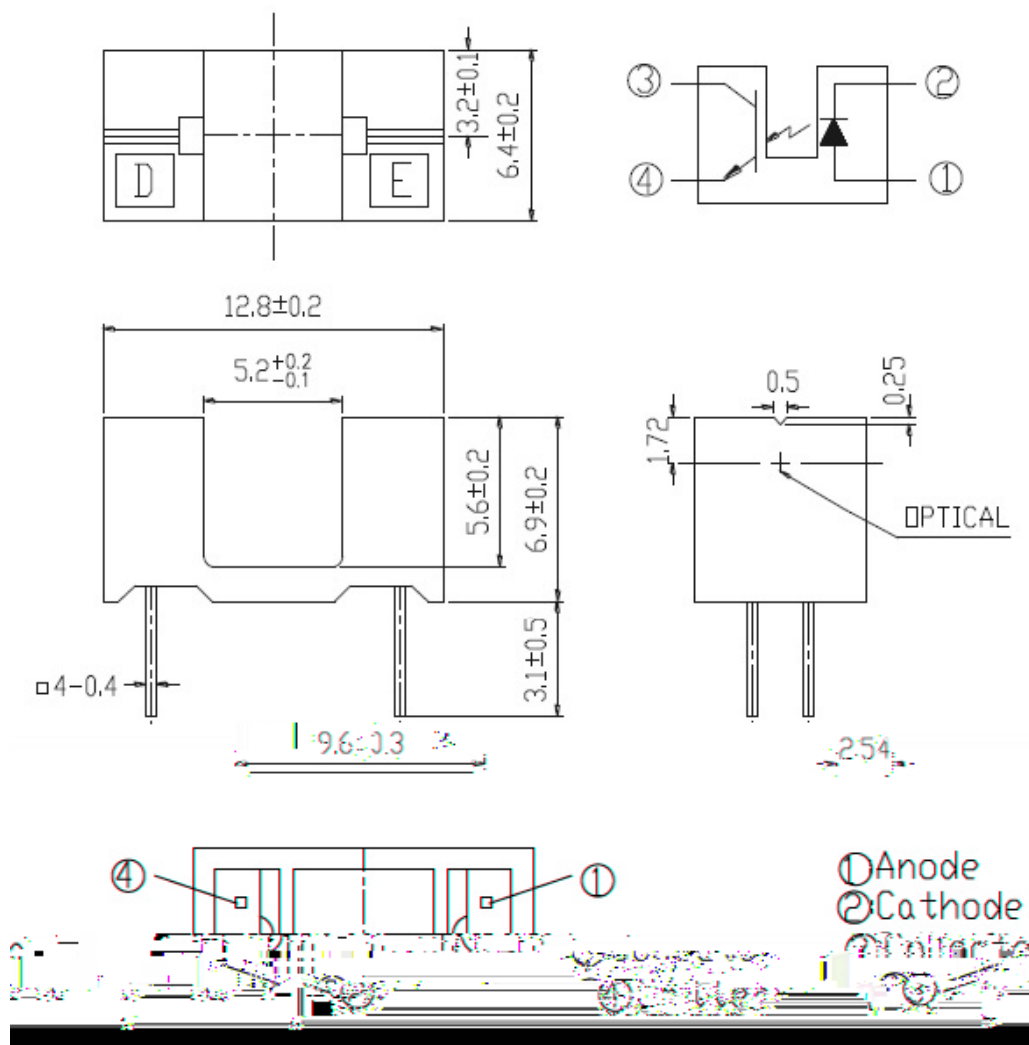

Notes:

1. All dimensions are in millimeters.
2. Tolerances unless dimensions ± 0.2 mm.

Absolute Maximum Ratings (Ta=25)

Parameter		Symbol	Ratings	Unit
Input	Power Dissipation at(or below) 25 Free Air Temperature	P_d	75	mW
	Reverse Voltage	V_R	5	V
	Forward Current	I_F	50	mA
	Peak Forward Current(*1) Pulse width 100μs, Duty cycle=1%	I_{FP}	1	A
Output	Collector Power Dissipation	P_C	75	mW
	Collector Current	I_C	20	mA
	Collector-Emitter Voltage	V_{CEO}	30	V
	Emitter-Collector Voltage	V_{ECO}	5	V
Operating Temperature		T_{opr}	-25~+85	
Storage Temperature		T_{stg}	-40~+85	
Lead Soldering Temperature (*2) (1/16 inch from body for 5 seconds)		T_{sol}	260	

(*1) $t_w = 100 \mu\text{sec.}$, $T = 10 \text{ msec.}$ (*2) $t = 5 \text{ Sec.}$

Electro-Optical Characteristics (Ta=25)

Parameter		Symbol	Min.	Typ.	Max.	Unit	Condition
Input	Forward Voltage	V_F	---	1.2	1.6	V	$I_F = 20\text{mA}$
	Reverse Current	I_R	---	---	10	μA	$V_R = 5\text{V}$
	Peak Wavelength	λ_P	--	940	---	nm	$I_F = 20\text{mA}$
Output	Collector Dark Current	I_{CEO}	---	---	100	nA	$V_{CE} = 10\text{V}$, E

E A

Typical Electrical/Optical/Characteristics Curves for IR

Fig.1 Forward Current vs. Ambient Temperature

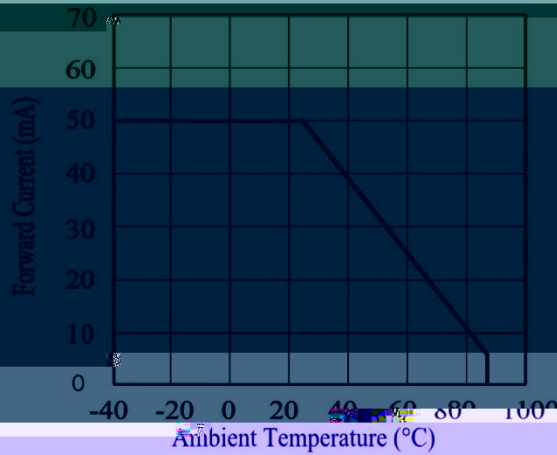

Fig.2 Spectral Distribution

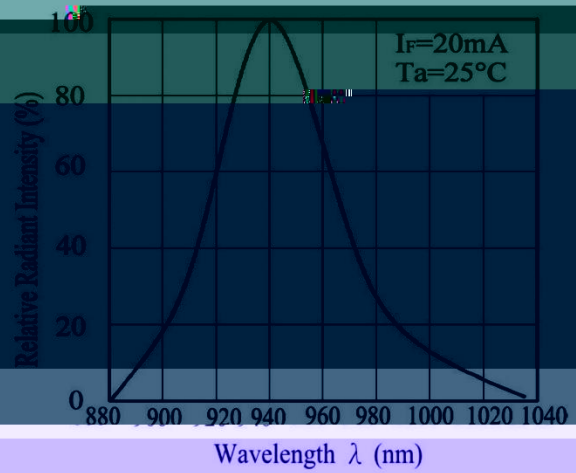

Fig.3 Forward Current vs. Forward Voltage

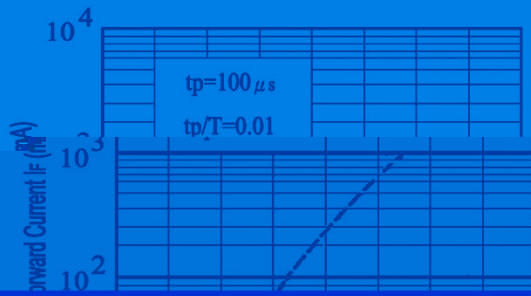
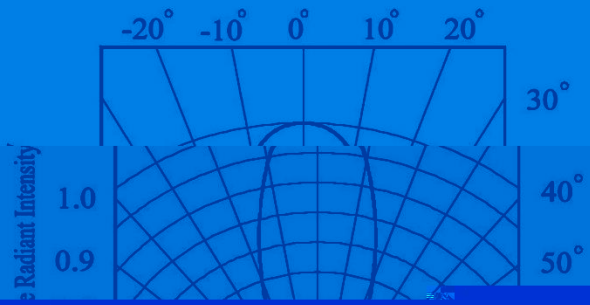

Fig.4 Relative Radiant Intensity vs. Angular Displacement



Typical Electrical/Optical/Characteristics Curves for PT

Fig.1 Spectral Sensitivity

Fig.2 Collector Current vs. Irradiance

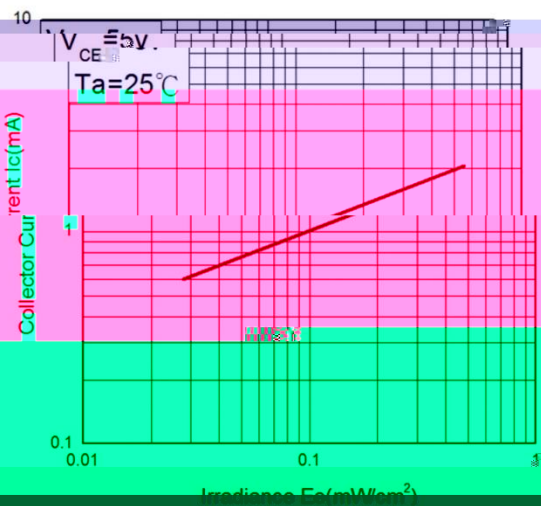
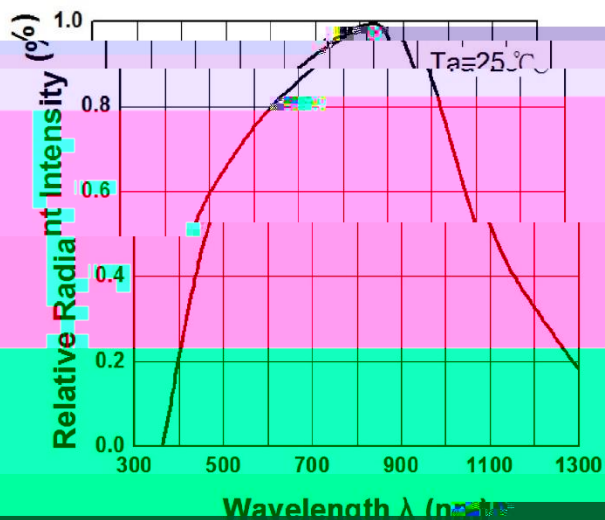

Fig.3 Collector Current vs. Collector Voltage

