

LIGHT ELECTRONICS CO., LTD.



Part No.	LG-IRM2A438KSF3		
-----------------	------------------------	--	--

1

IRM2A438 SF3 PIN
 IC,
 REACH RoHS

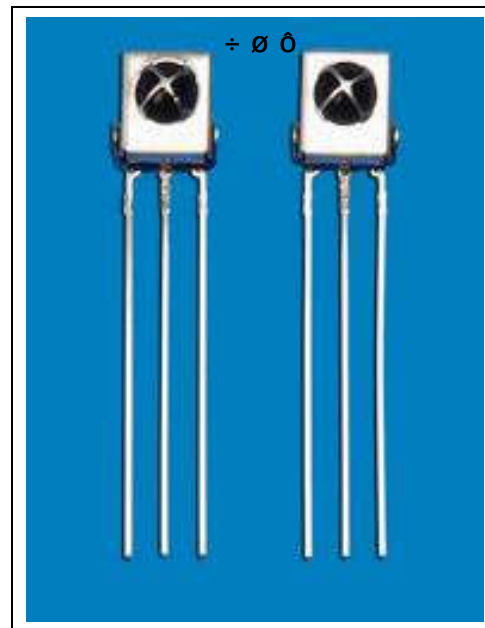

2

2.7-5.5V

TTL CMOS

3

:
 (MP3 MP4, à à æ ç è
 é ê ë ì í î é ê í ç ì
 ò ñ ò

4 0 0 :

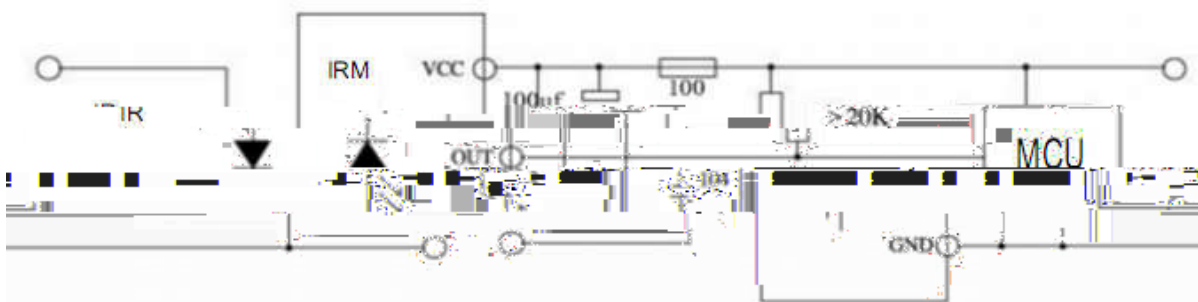

5 0 0 0

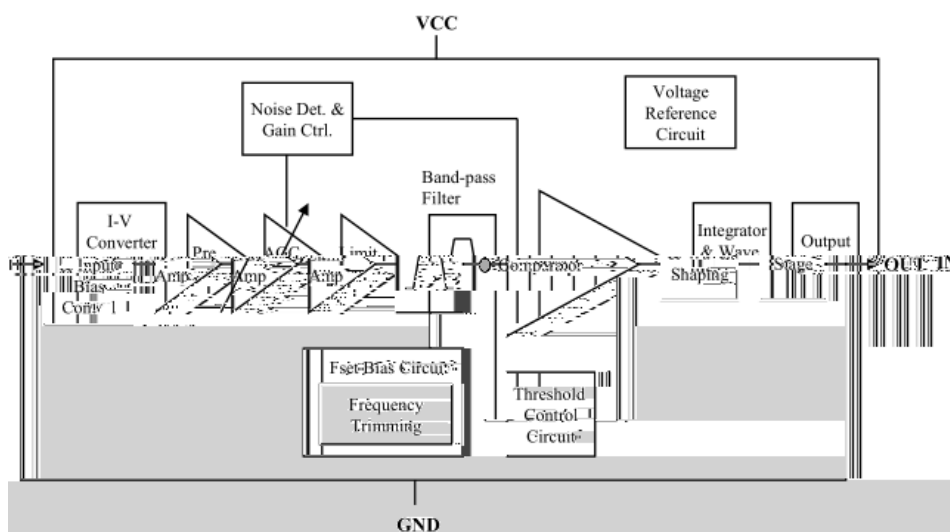

LIGHT ELECTRONICS CO., LTD.

L

LIGHT ELECTRONICS CO., LTD.

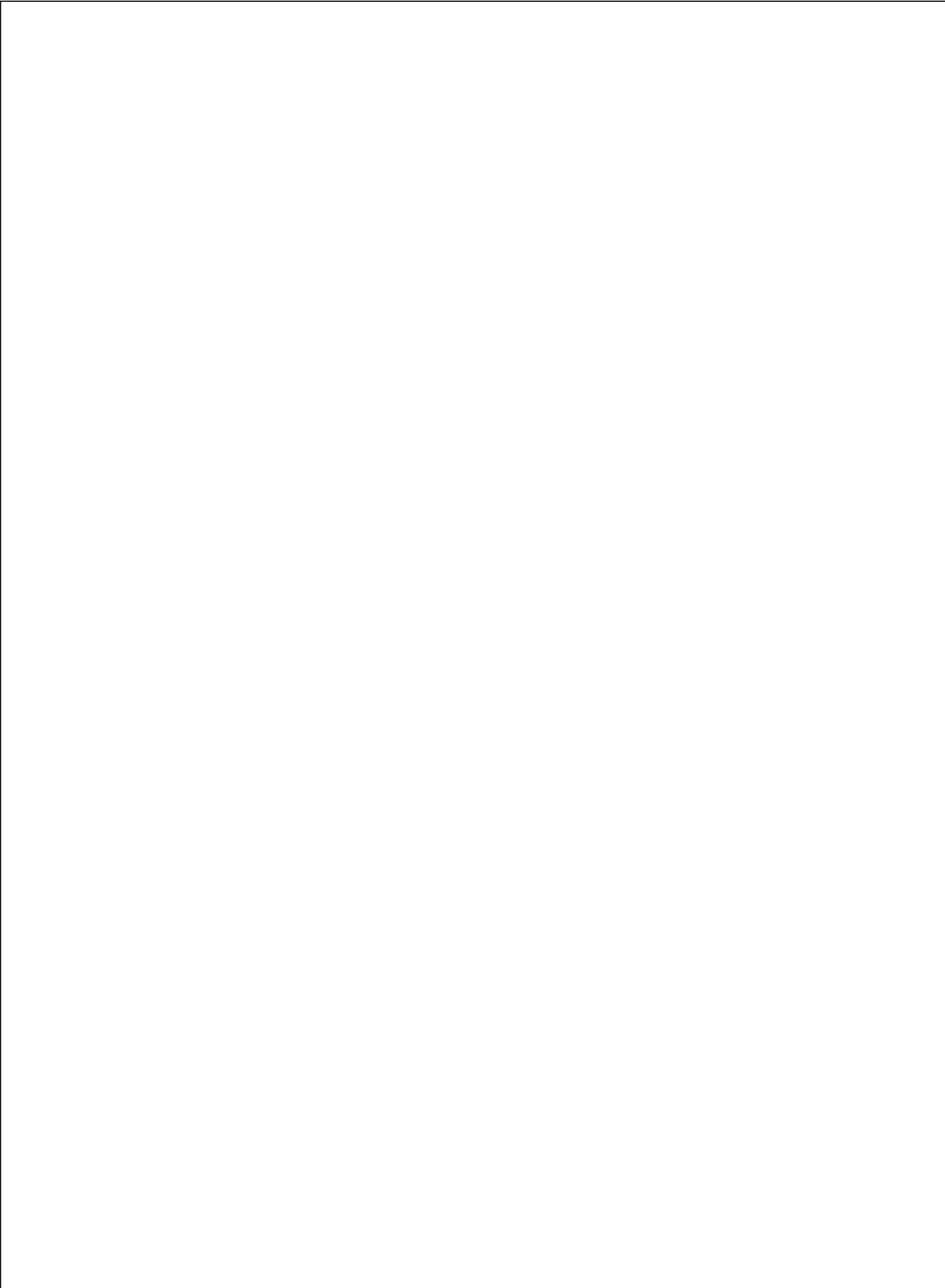

1a

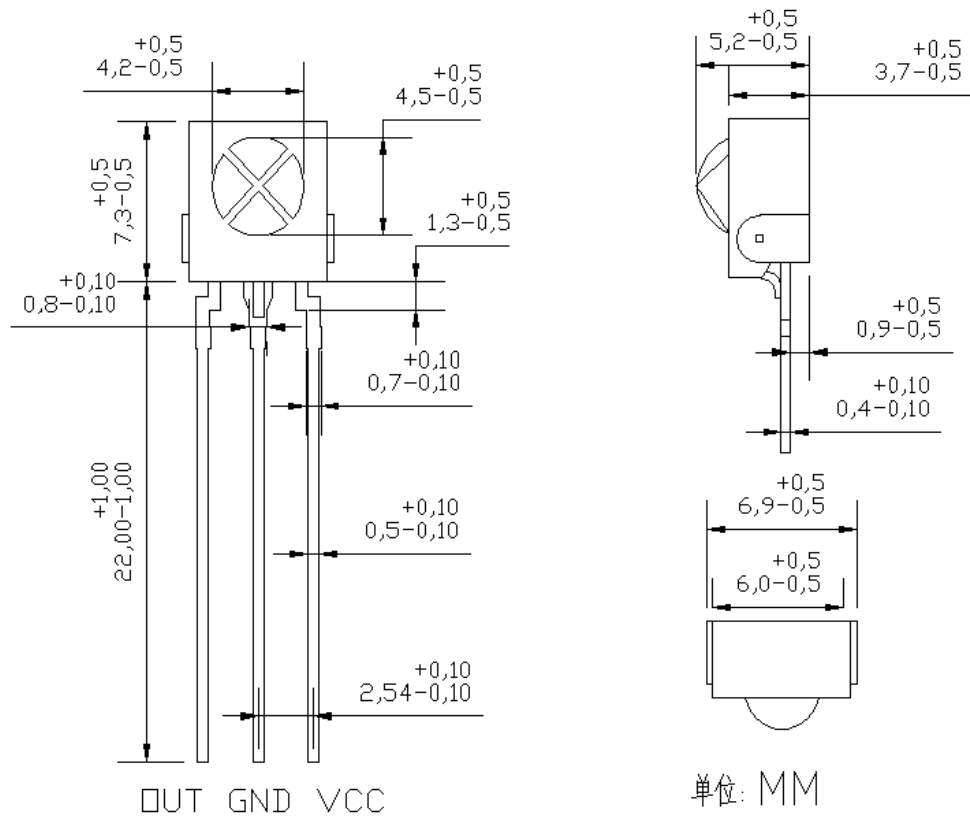

15

1è.

: 26pü 5

2

3a

16.

1è. ë ô ï

ú 5pPCS

2è.

ô

ú 5pPCS

1p

ã

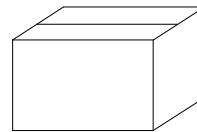
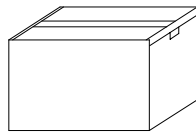
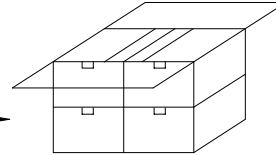
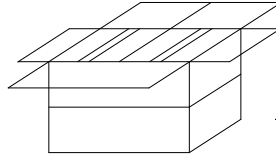
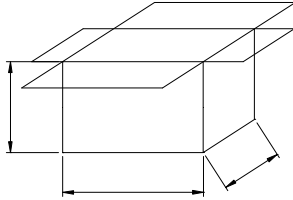
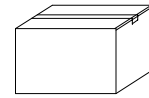
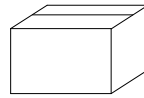
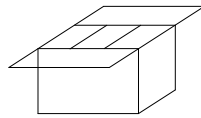
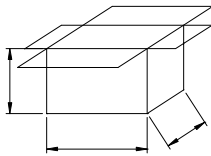
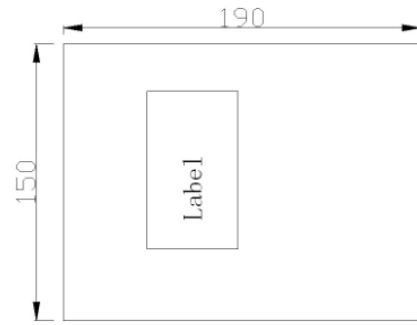

(pcs /)	(/)	(/)
500	10	4