

Features

- ◆ Pb free product RoHS compliant
- ◆ Low power consumption, High efficiency
- ◆ General purpose leads
- ◆ Reliable and rugged
- ◆ Long life solid state reliability
- ◆ Radiant angle: 30 °

Package Dimension

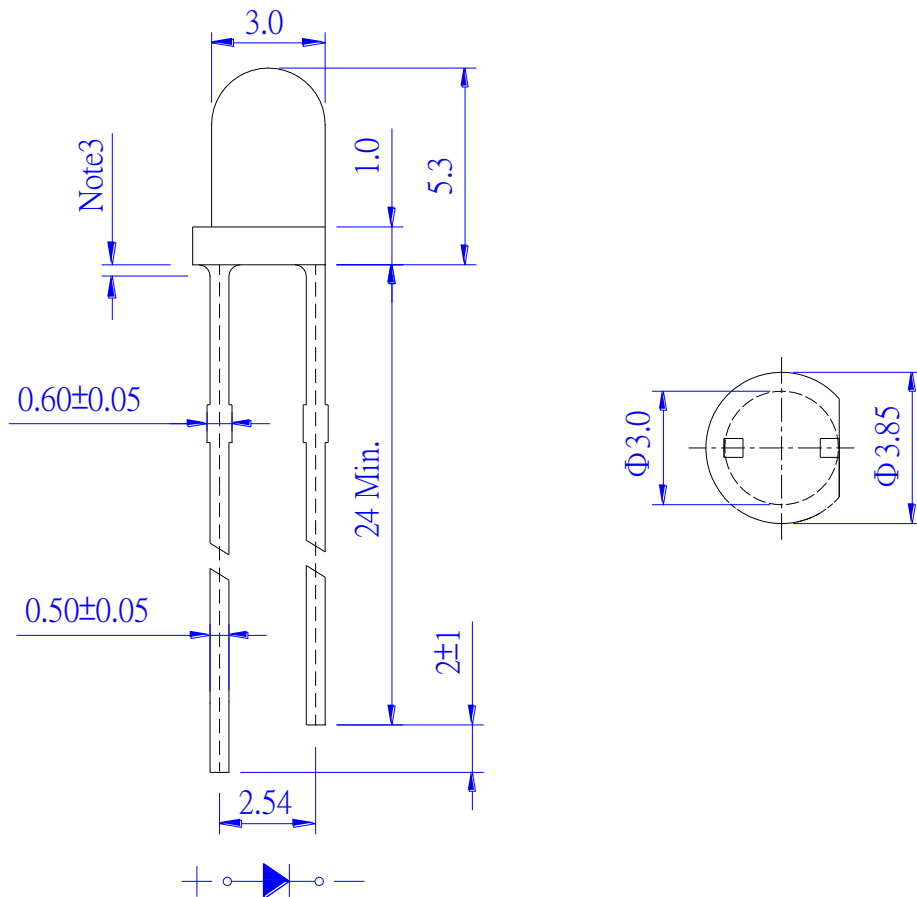

Part NO.	Chip Material	Lens Color
LG-03IR4C94C-302BA	AlGaAs	Water Clear

Notes:

1. All dimensions are in millimeters.
2. Tolerance is ±0.20mm unless otherwise noted.
3. Protruded resin under flange is 1.0mm max.
4. Lead spacing is measured where the leads emerge from the package.
5. Specifications are subject to change without notice.

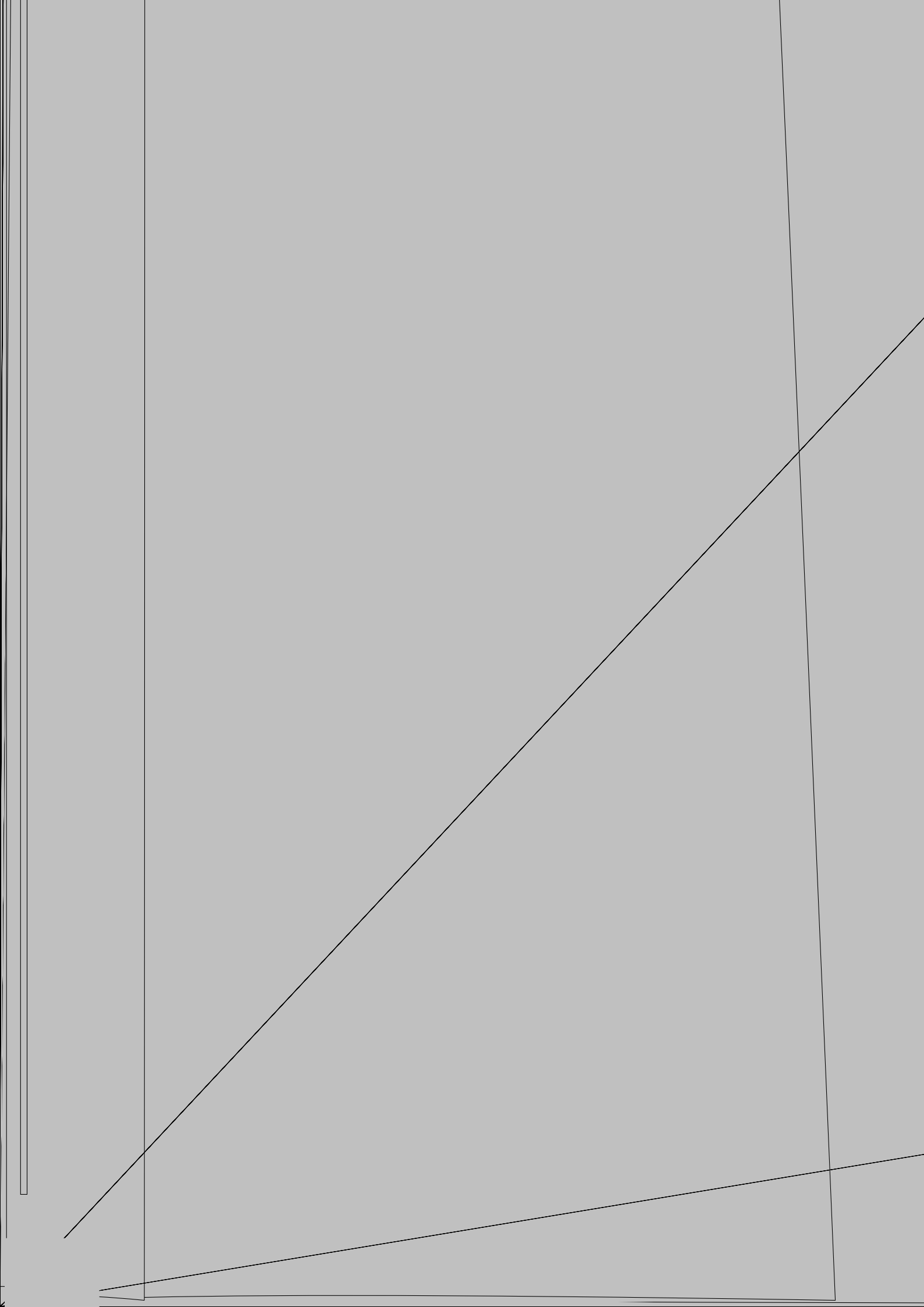

Electrical Optical Characteristics at Ta=25

Parameter	Symbol	Min.	Typ.	Max.	Unit	Test Condition
Radiant Intensity	I _e	25	35	51.8	mW/sr	I _F =50mA (Note 1,3)
Viewing Angle	1/2	25	30	35	Deg.	(Note 2)
Peak Wavelength		---	940	---	nm	I _F =20mA
Spectral Line Half- Width	Δ	---	50	---	nm	I _F =20mA
Forward Voltage	V _F	---	1.25	1.5	V	I _F =50mA
Reverse Current	I _R	---	---	100	μA	V _R =5V

Note:

1. Point sources of the amount of radiation per unit time in a given direction within the unit solid Angle radiated energy.
2. 1/2 is the off-axis angle at which the Radiant Intensity is half the axial Radiant Intensity.
3. The I_e guarantee should be added ±15% tolerance.

Recommended Wave Soldering Profile

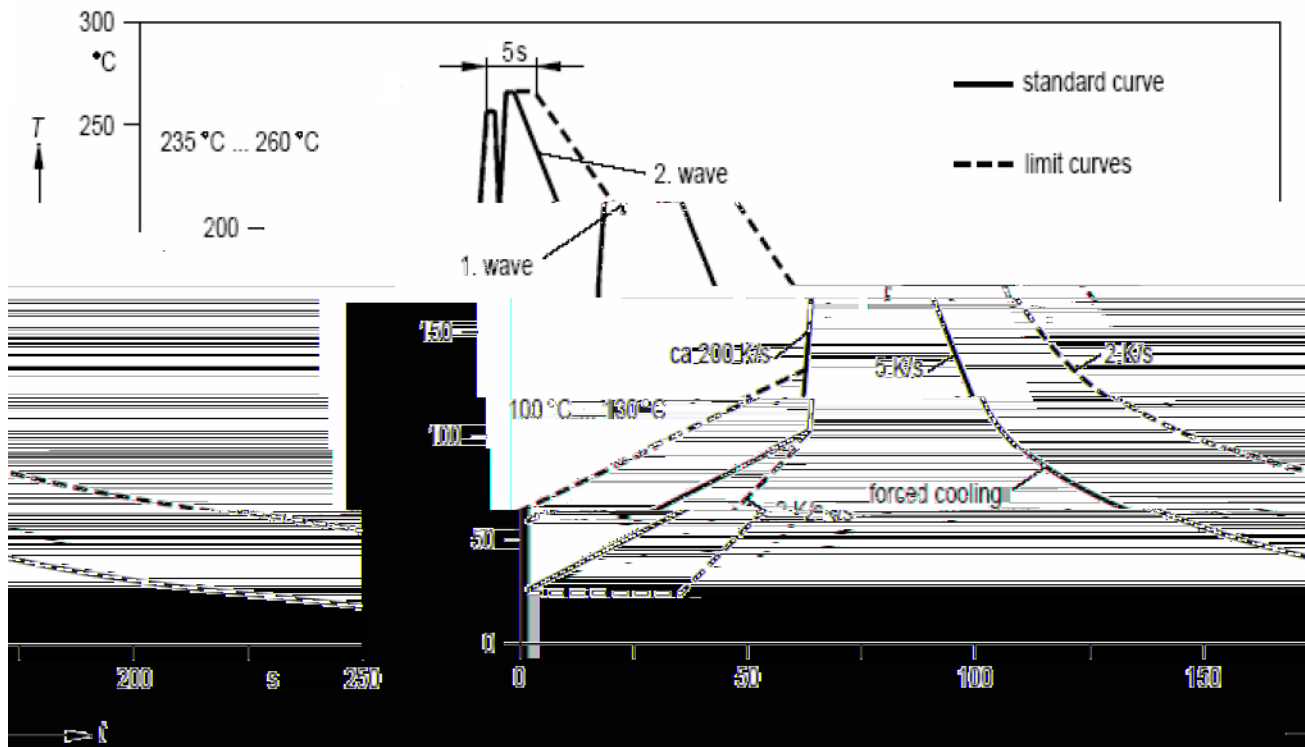

Typical Electrical / Optical Characteristics Curves (25 Ambient Temperature Unless Otherwise Noted)

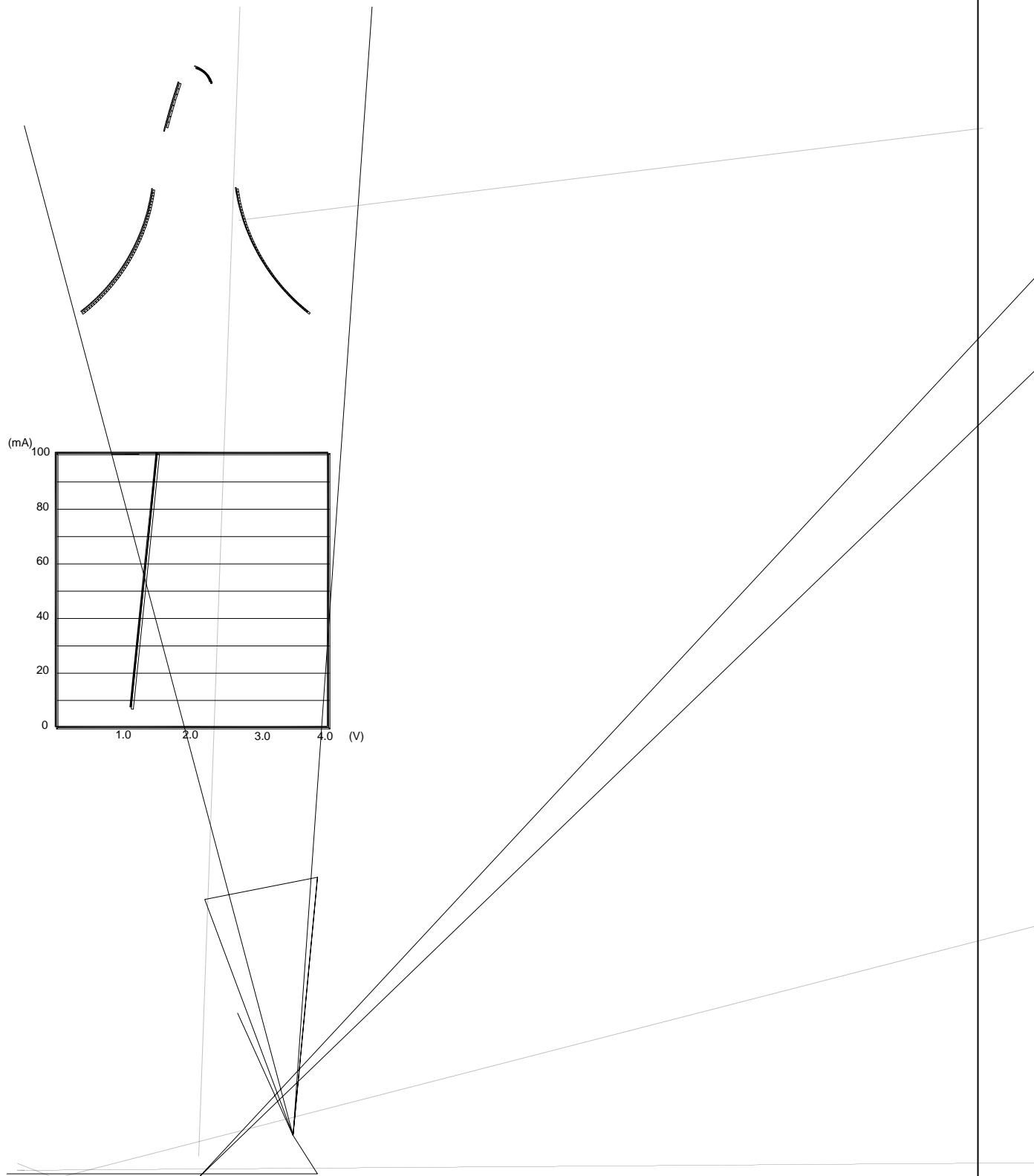

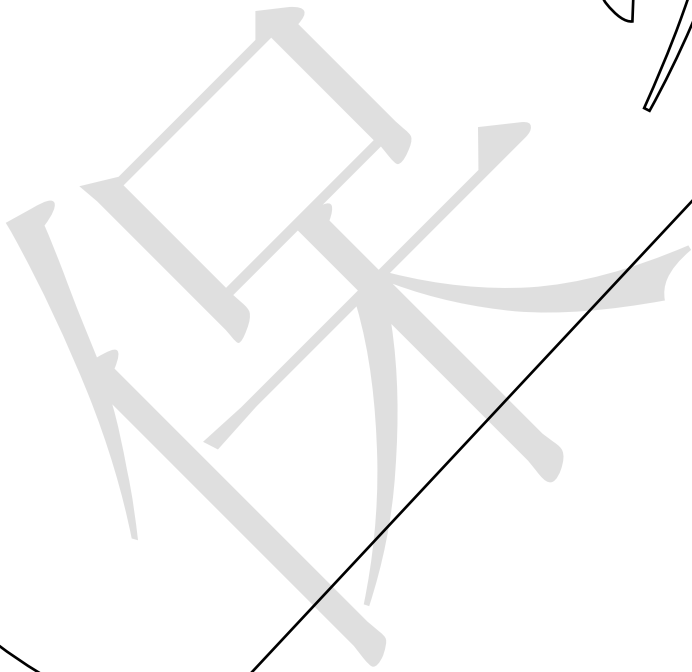
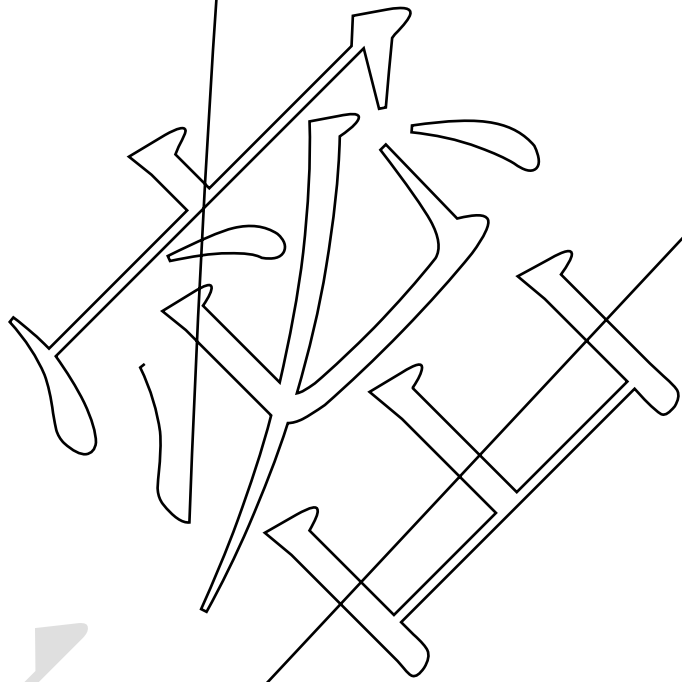

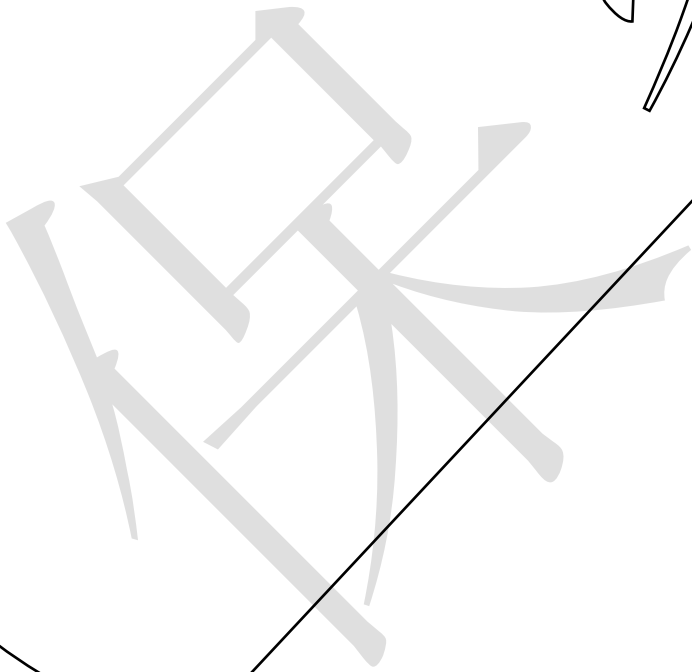
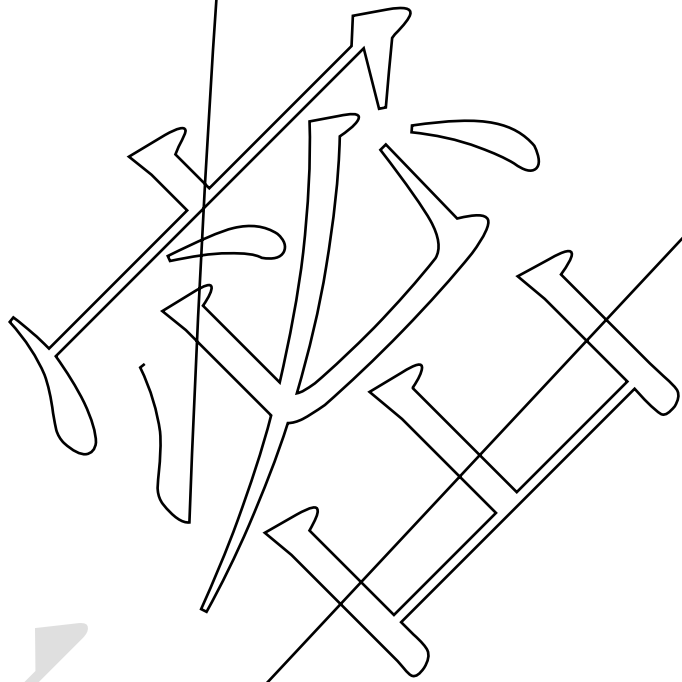

PACKAGE

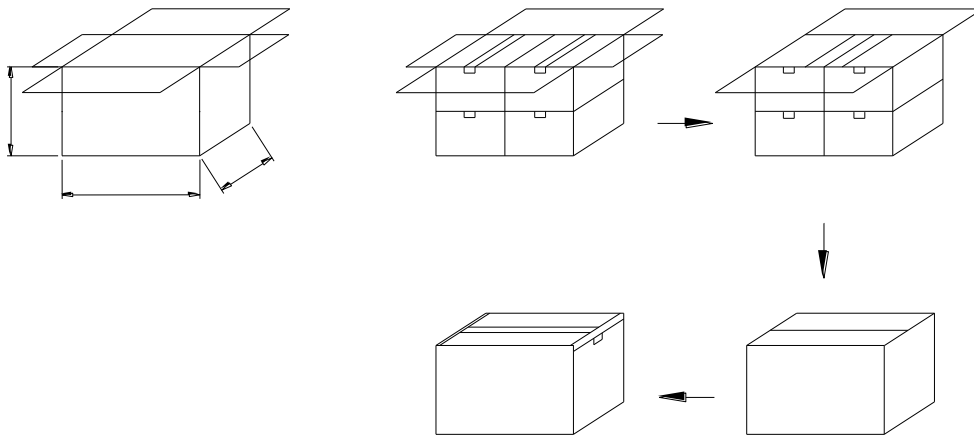
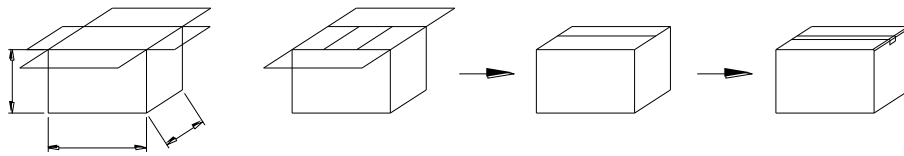
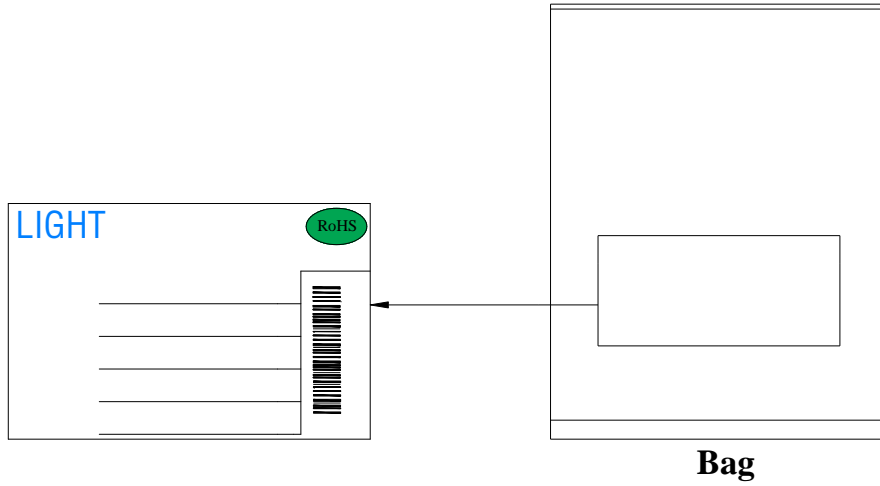

Bag minimum volume (pcs / Bag)	Bag volume (pcs / Bag)	Inner box volume (Bag / box)	Outer carton volume (Box / Carton)
250	1000	10	4

Radiant Intensity Bin Code (IF=50mA)

BIN CODE	Min. (mW/sr)	Max. (mW/sr)
4	25	30
5-A	30	32.9
5-B	32.9	35.2
6	35.2	43.2
7	43.2	51.8

NOTE: The I_e guarantee should be added $\pm 15\%$ tolerance.