

SL-T3011IRC020-L125

DATA SHEET

SPEC. NO. : SZ19022001
DATE : 2019/12/15
REV. : A/3

Approved By:

Checked By:

Prepared By:

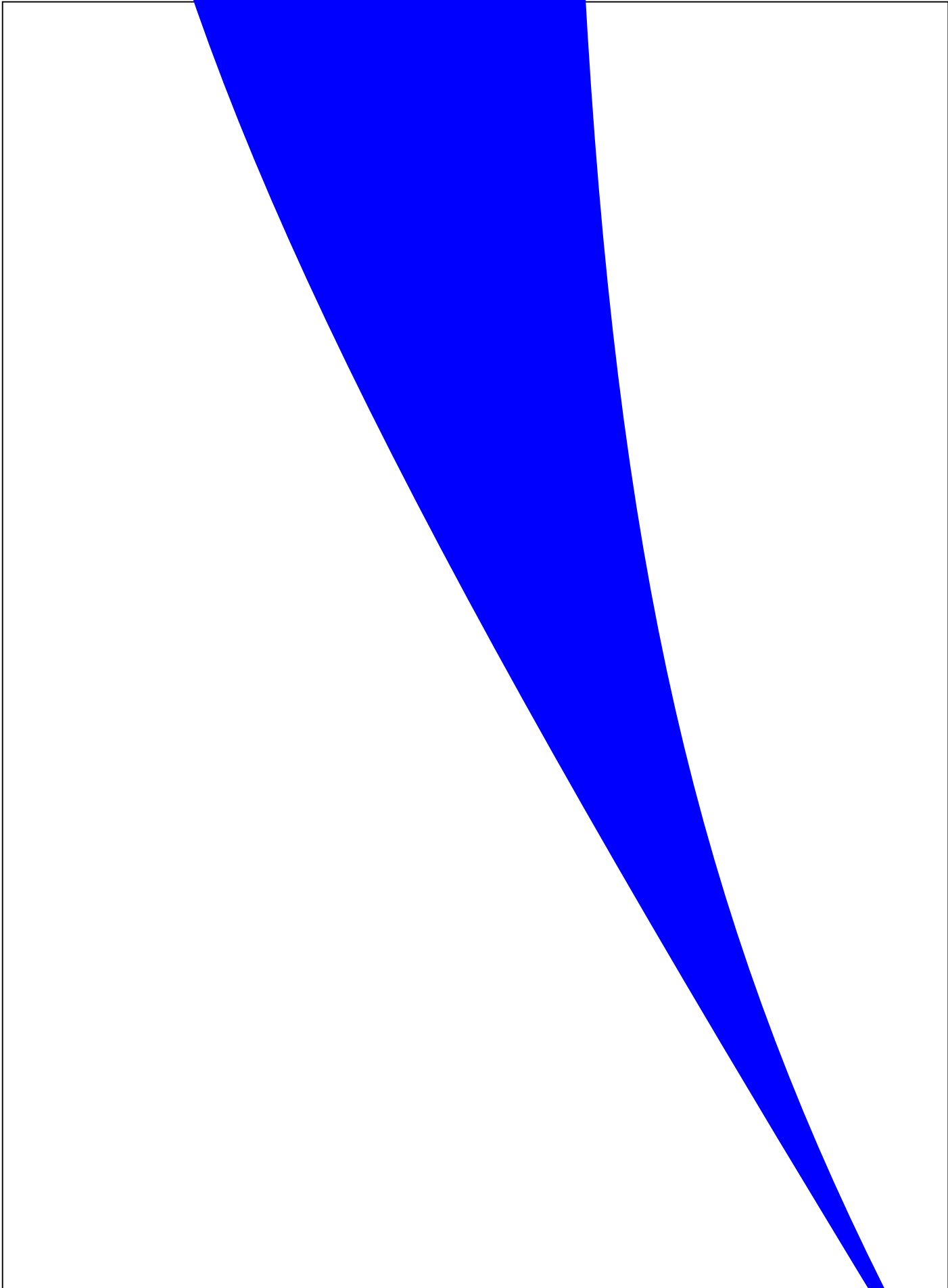

Absolute Maximum Ratings at Ta=25

Parameter	MAX.	Unit
Power Dissipation	50	mW
Continuous Forward Current	30	mA
Peak Forward Current ^{*2}	100	mA
Reverse Voltage	5	V
Electrostatic Discharge (HBM) ^{*3}	4000	V
Moisture Sensitivity Level ^{*1}	5a	
Operating Temperature	-40 to + 85	
Storage Temperature	-40 to + 100	
Reflow Condition	260 MAX for 10 Seconds	

1. Storage

- (1). Storage requirements before vacuum bag opened: Temperature<30 , Humidity<65%RH;
- (2). Check air leakage and vacuum bag damage before opened. If there is any issue found, check the humidity indicator card immediately after bag opened:
 - a. If color changes on “10% circle” of the humidity indicator card only and not the circles of 20% and above, components can be used without additional handling;
 - b. If color changes on both 10% and 20% circles but not the circles of 30% and above, components must be dehumidified according to the conditions of bullet (5);
 - c. If color changes on 10%, 20%, and 30% circle or above, the product should be returned to the supplier for high temperature dehumidification;
- (3). After bag opened, manual soldering or reflow process must follow the following requirements:
 - a. Complete soldering / reflow within 24 hours;
 - b. Requirements of working environment: Temperature<30 , Humidity<60%RH;
- (4). If the working condition is outside (3)a requirement, the components must be dehumidified according to the conditions of bullet (5);
- (5). Low temperature dehumidification: temperature 60-65 , at least 24 hours;
- (6). Shelf life: 30 days. If it's over 30 days from the production date on the package label, the components must be dehumidified according to the condition of bullet (5). If customer is unable to dehumidify, return components to LIGHT for dehumidification.

2. Peak Forward Current:

Condition for is IFP pulse Pulse Width 100µs and duty 1%.

3. Caution in ESD:

Static Electricity and surge damages the LED. It is recommend to use a wrist band or anti-electrostatic glove when handling the LED. All devices, equipment and machinery must be properly grounded.



Typical Electrical / Optical Characteristics Curves
(25°C unless otherwise noted)

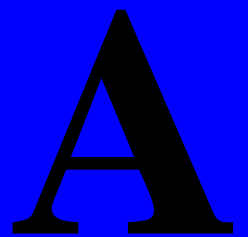
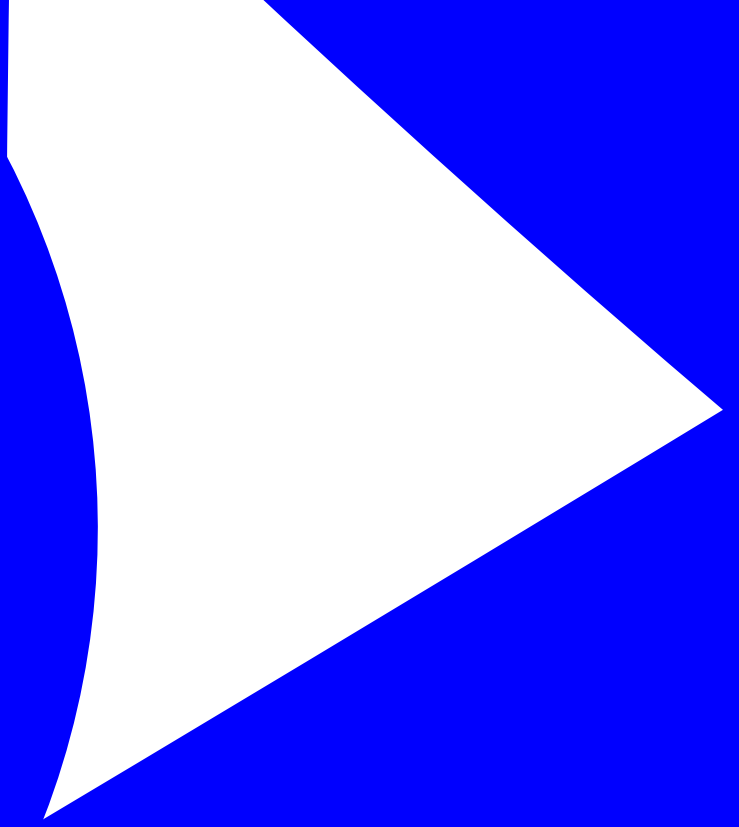





Label Explanation

LIGHT Universal Label
(Reel Label)

	
LIGHT Light Electronics CO., LTD.	
MODEL NAME:	 LOT NO:
QUANTITY:	
BIN:	
PACKING DATE:	
REMARKS:	

Customer Defined Label
(Aluminum Moisture Proof Bag Label)

	
LIGHT Light Electronics CO., LTD.	
MODEL NAME:	 LOT NO:
QUANTITY:	
BIN:	
PACKING DATE:	
CUSTOMER P/N:	

Reel Dimensions

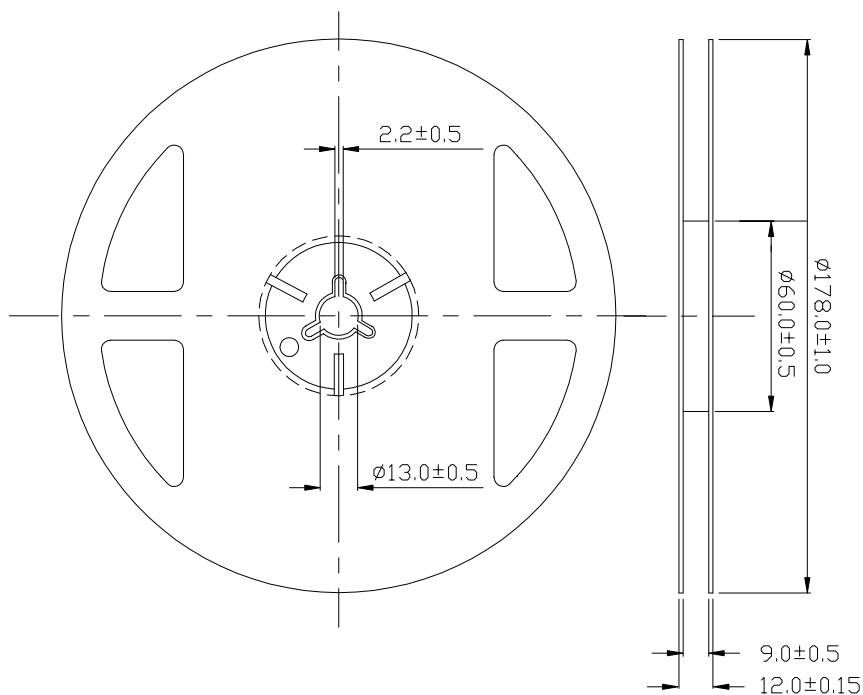

Note: Tolerance unless mentioned is $\pm 0.2\text{mm}$; Unit = mm

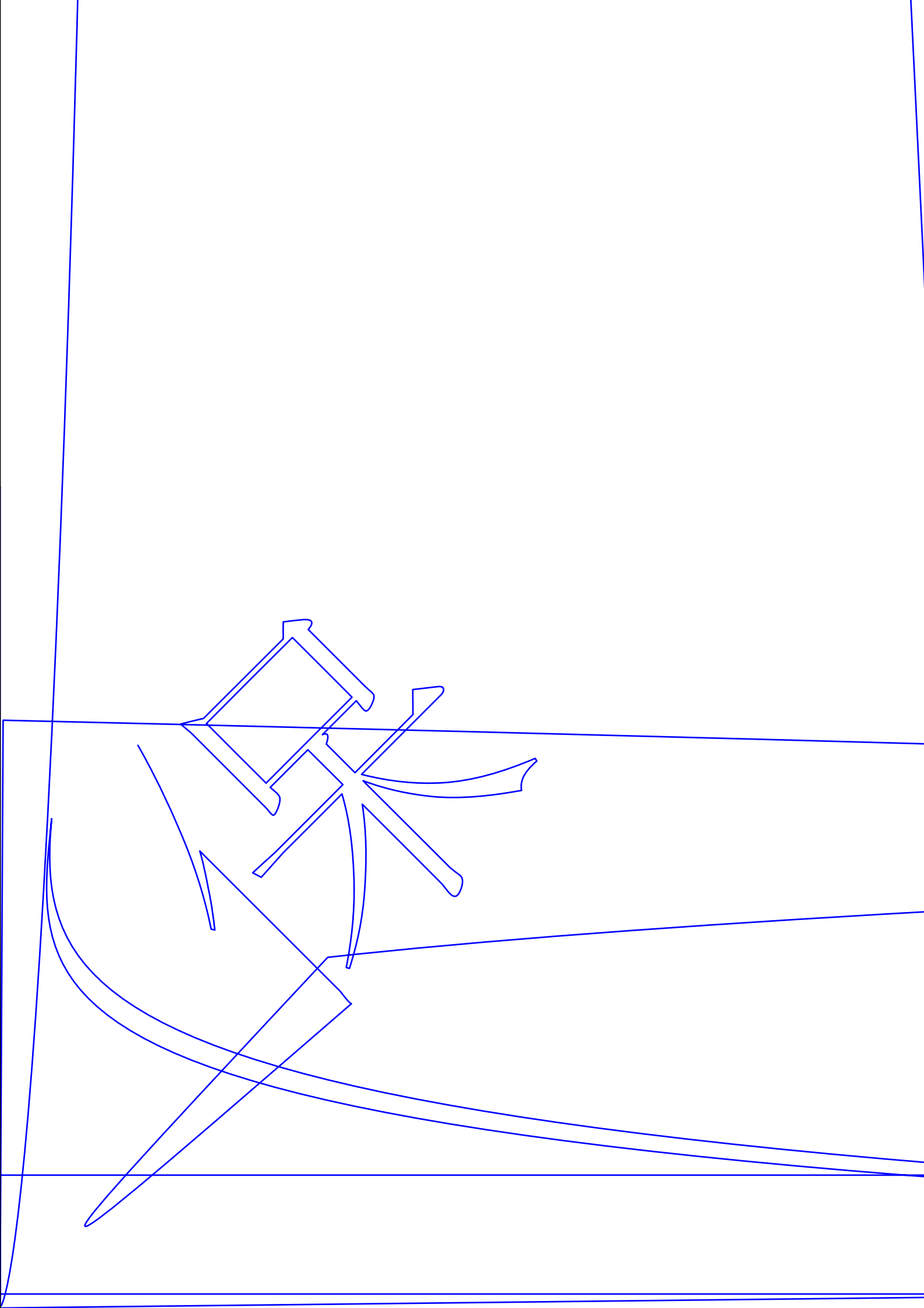

Suggest IR Reflow Condition For Lead Free

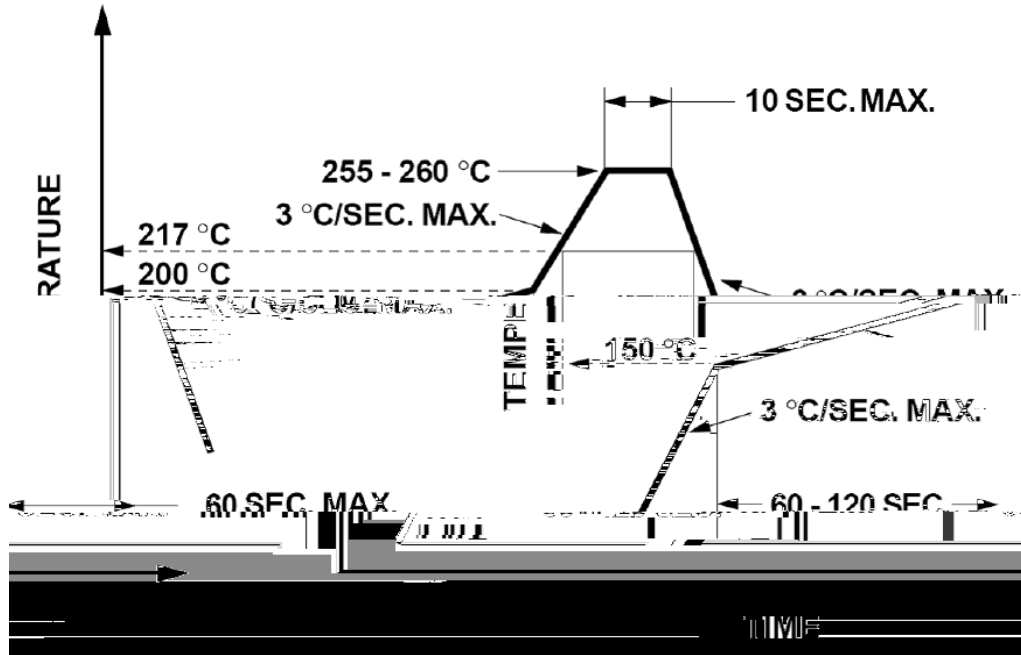

1. Reflow soldering should not be done more than two times.
2. When soldering, do not put stress on the LEDs during heating.

Soldering iron

1. When hand soldering, the temperature of the iron must less than 300 for 3 seconds.
2. The hand solder should be done only once.

Repairing

Repair should not be done after the LEDs have been soldered. When repairing is unavoidable, a double-head soldering iron should be used (as below figure). It should be confirmed beforehand whether the characteristics of LEDs will or will not be damaged by repairing.

