

Features

- ◆ Pb free product—RoHS compliant
- ◆ Low power consumption, High efficiency
- ◆ Reliable and rugged
- ◆ High luminous intensity
- ◆ Long life – solid state reliability
- ◆ Viewing angle: 120°(R/G/B)

Package Dimension

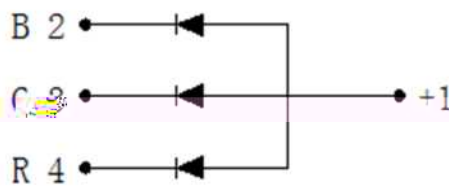
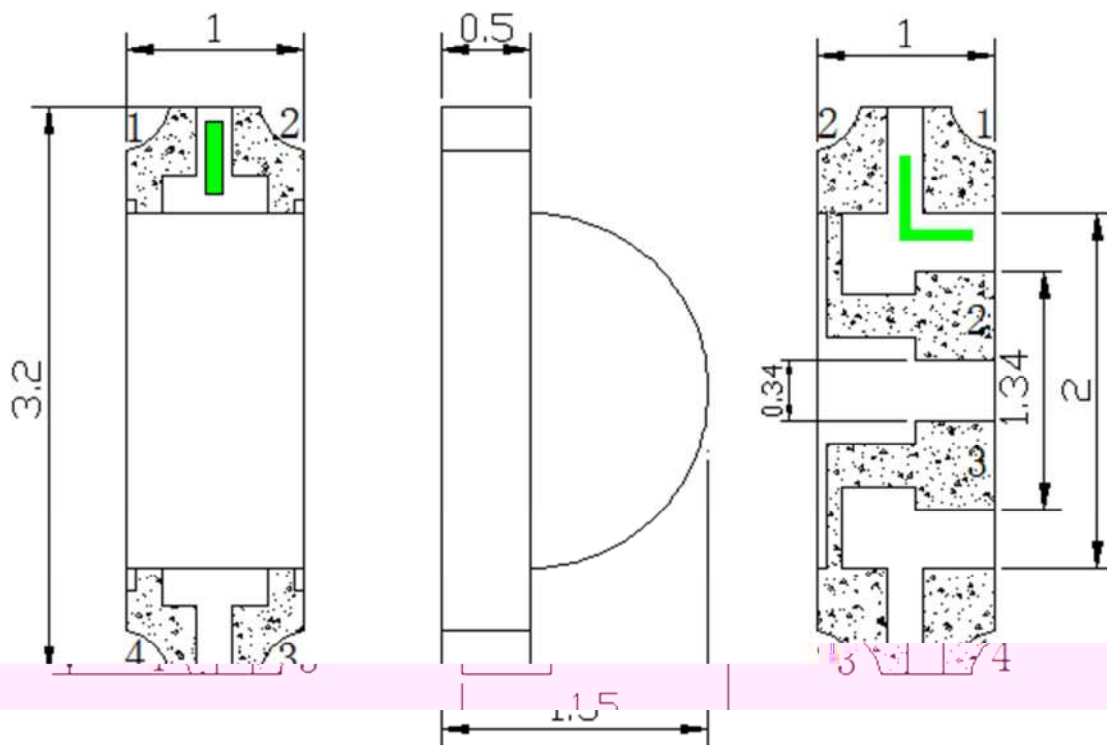

Part No.	Lens Color	Source Color
SL-T3210RGBC020-L150	Water Clear	Red/Green/Blue

Notes:

1. All dimensions are in millimeters.
2. Tolerance is $\pm 0.10\text{mm}$ unless otherwise noted.
3. Specifications are subject to change without notice.

Absolute Maximum Ratings at Ta=25

LIGHT

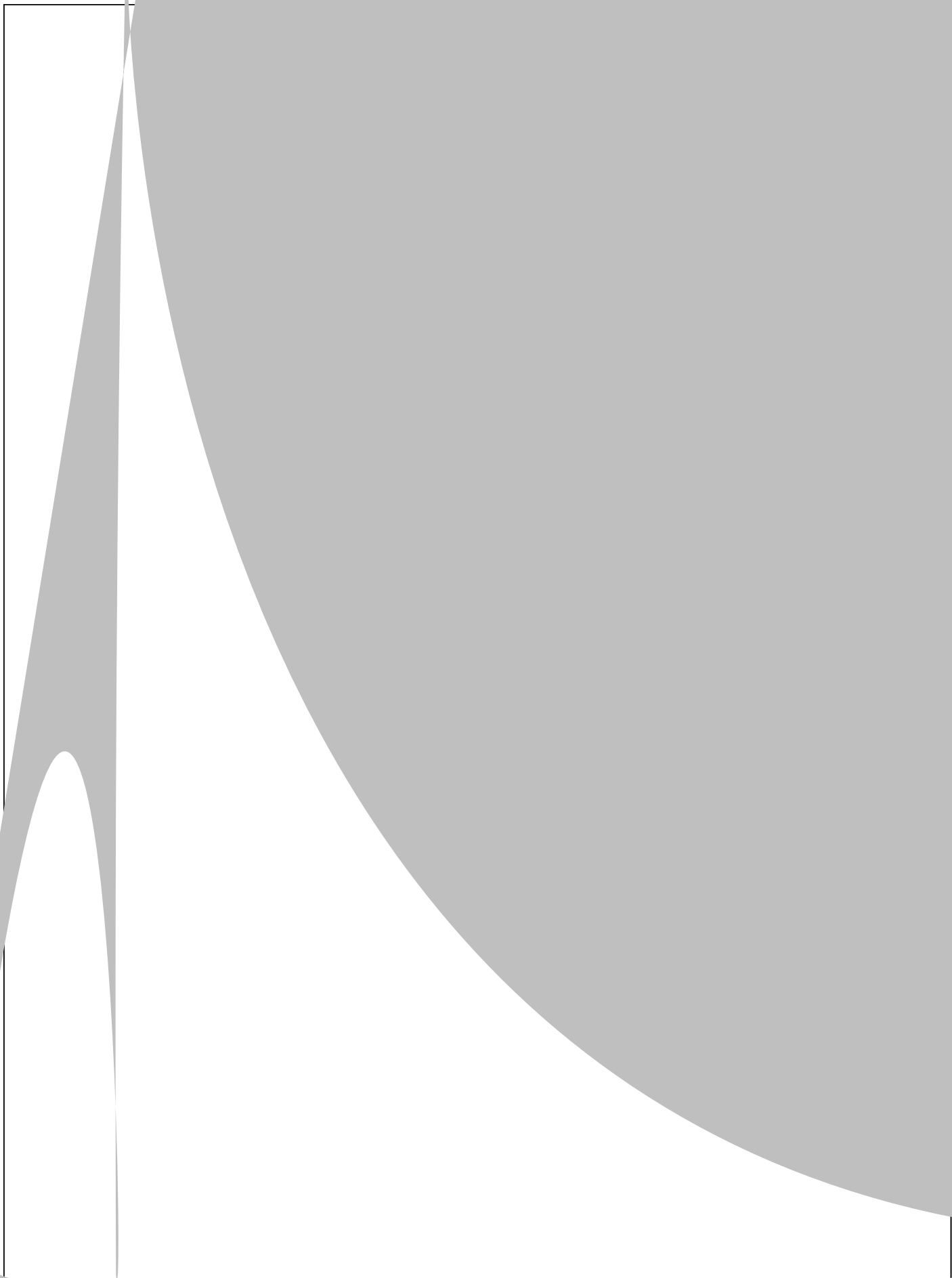

CS T3210RGBC020-L150







--

--

--

Label Explanation

LIGHT	
Light Electronics CO., LTD.	
MODEL NAME: _____	 LOT NO. : ON LOT
QUANTITY: _____	
BIN: _____	
PACKING DATE: _____	
REMARKS: _____	

LIGHT	
Light Electronics CO., LTD.	
MODEL NAME: _____	 LOT NO. : ON LOT
QUANTITY: _____	
BIN: _____	
PACKING DATE: _____	
CUSTOMER P/N: _____	

Reel Dimensions

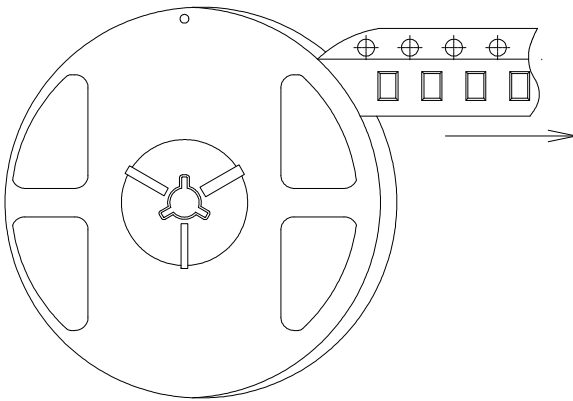

Note:

Carrier Tape Specifications (Loaded Quantity: 3000pcs/reel)

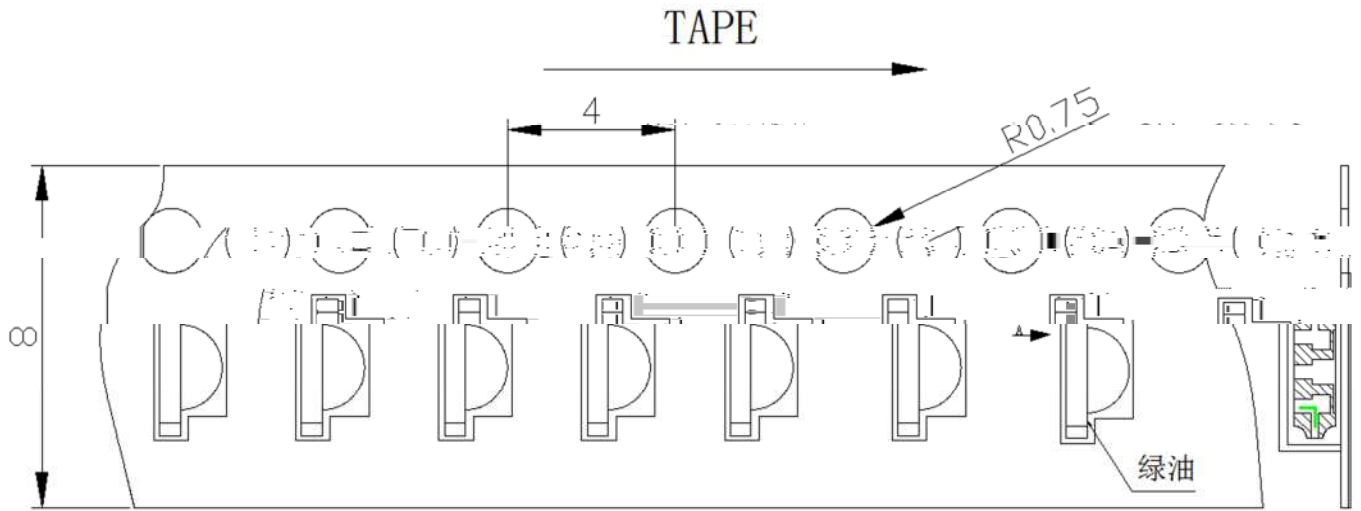

Moisture Resistant Packaging

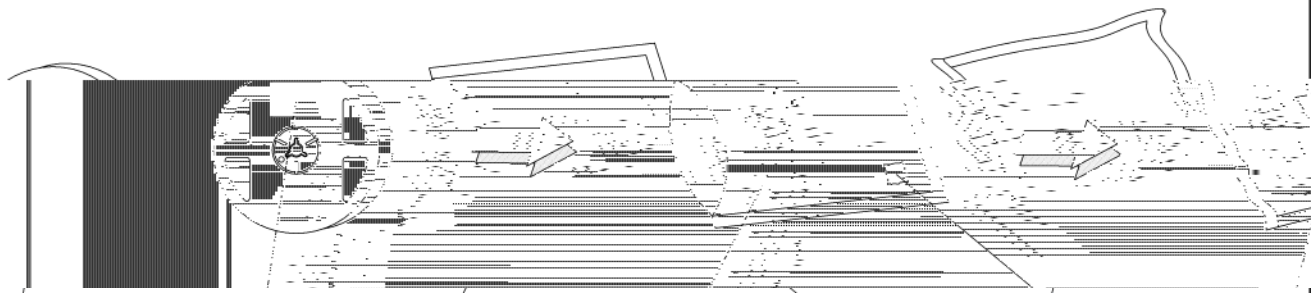

LIGHT universal Label

Aluminum moisture-proof bag

Desiccant

Customer defined Label or LIGHT universal Label

Suggest IR Reflow Condition For Lead Free

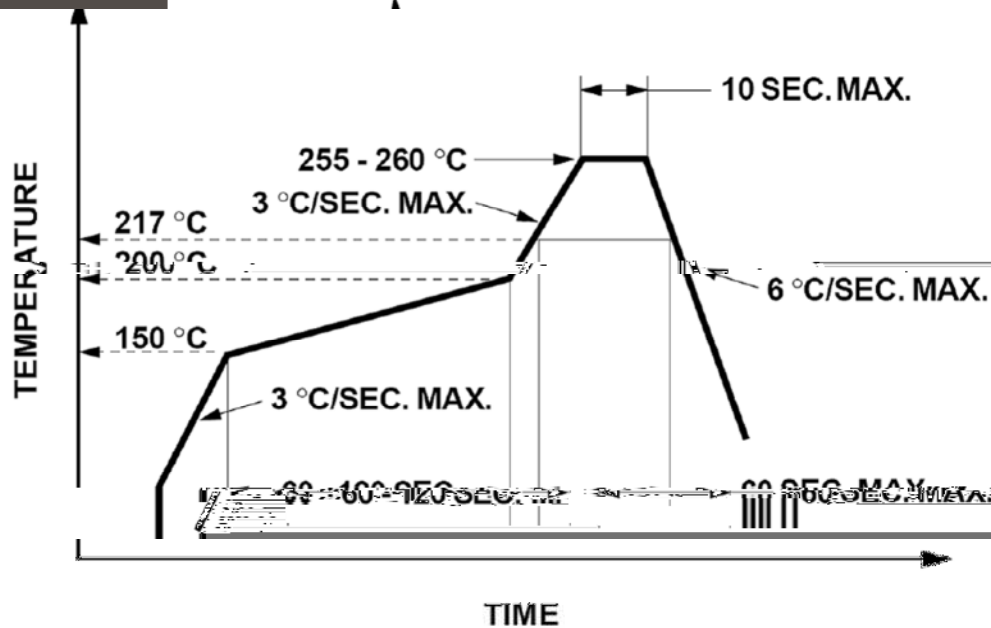

1. Reflow soldering should not be done more than two times.
2. When soldering, do not put stress on the LEDs during heating.

Soldering iron

1. When hand soldering, the temperature of the iron must less than 300°C for 3 seconds.
2. The hand solder should be done only once.

Repairing

Repair should not be done after the LEDs have been soldered. When repairing is unavoidable, a double-head soldering iron should be used (as below figure). It should be confirmed beforehand whether the characteristics of LEDs will or will not be damaged by repairing.

