

1.

2.

3.

4.

5.

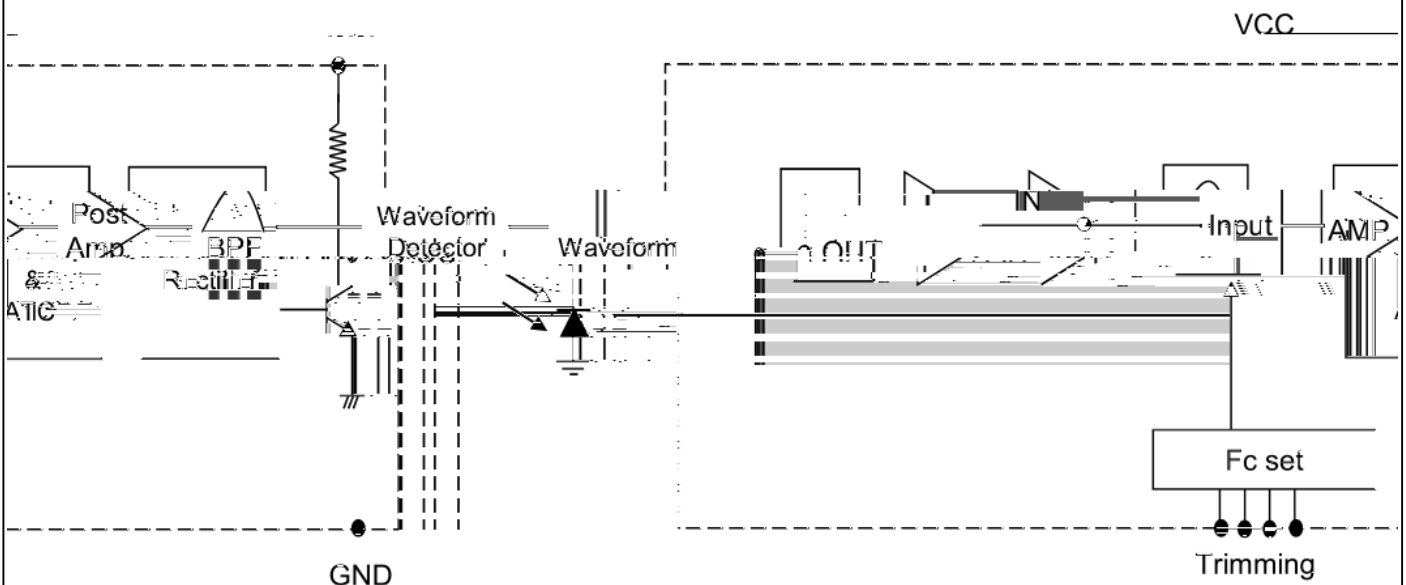
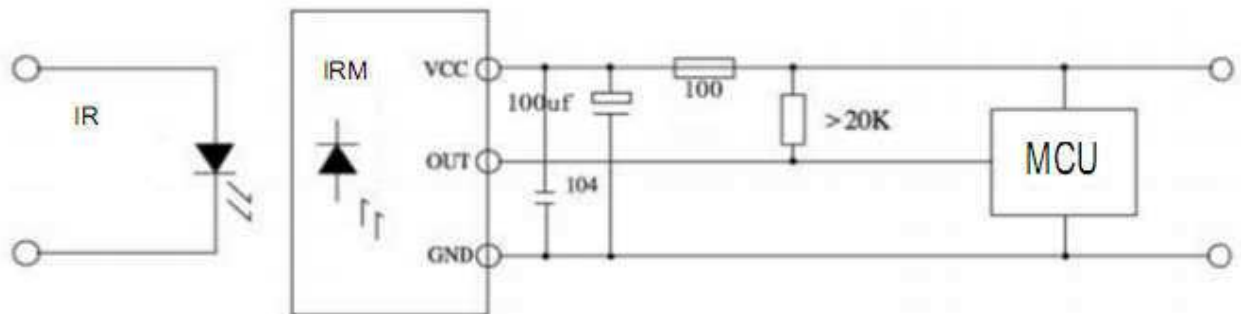
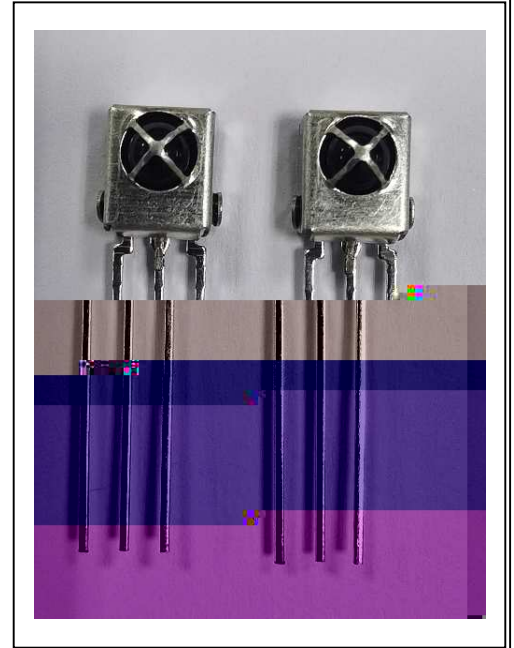

11.

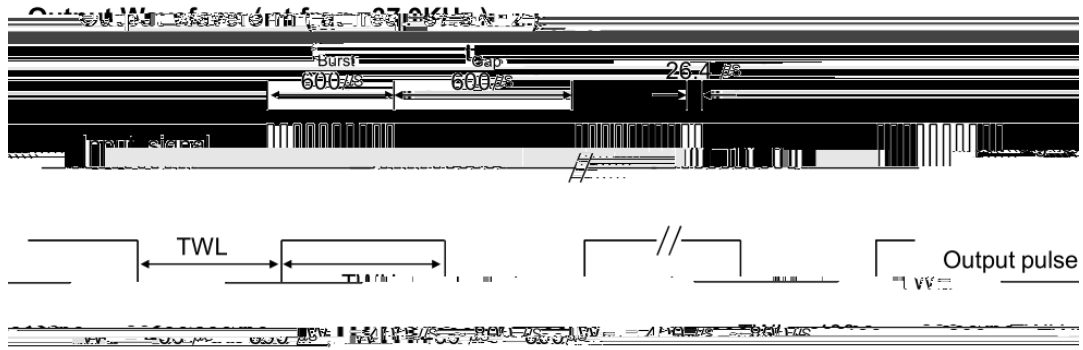

mended for optimal function.

* $t_{pi} \geq 10/f_0$ is recomi

12.

Minimum Burst Length t_{burst} (number of pulses per burst)	200us
Minimum Burst Gap time t_{burst_gap} (number of pulses per burst) between two bursts	300us
Minimum Full Frame time (for full frame repeat code)	< 1ms

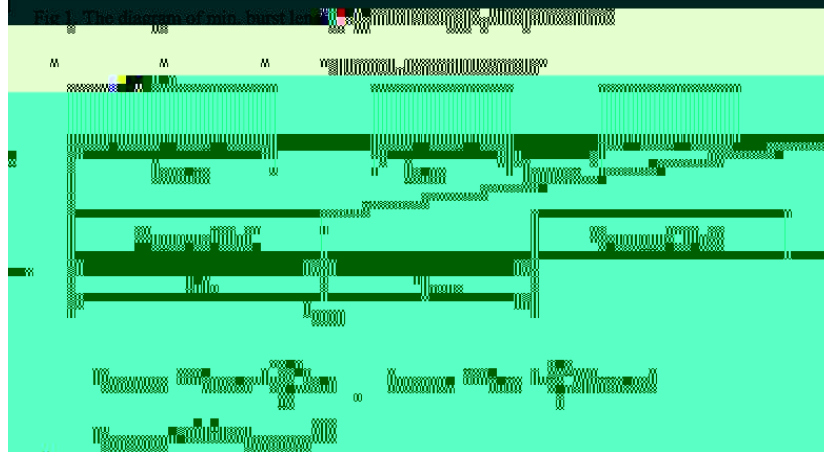

13.

	1.5k ,			

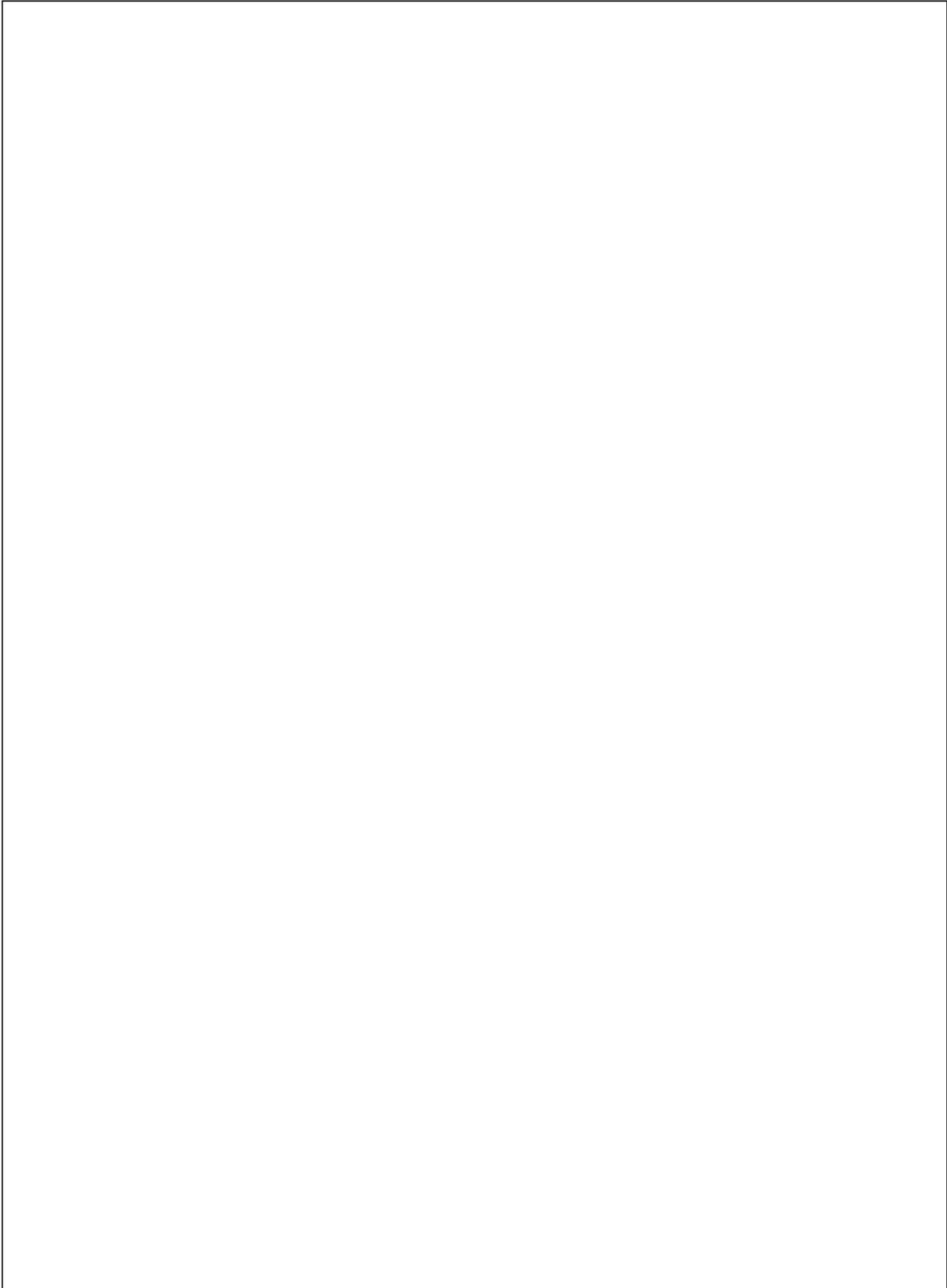

16.

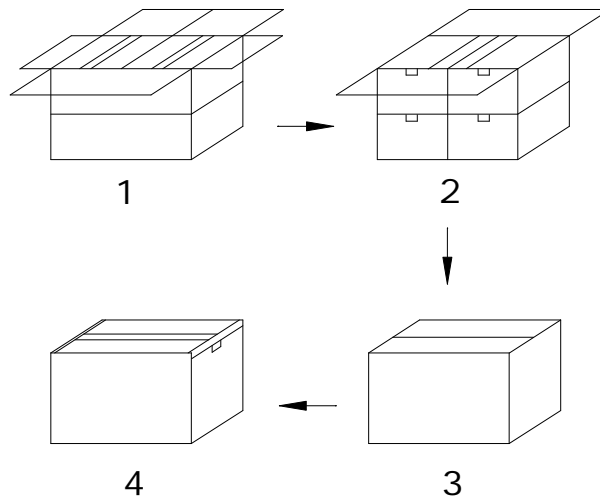
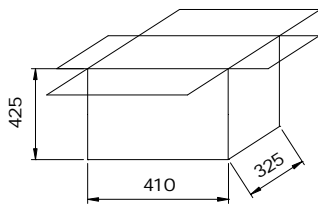
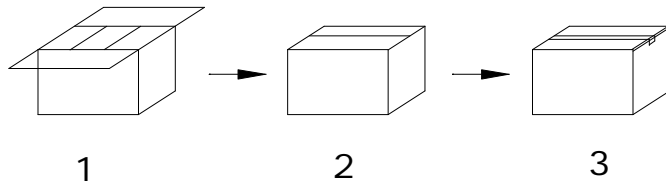
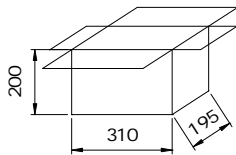
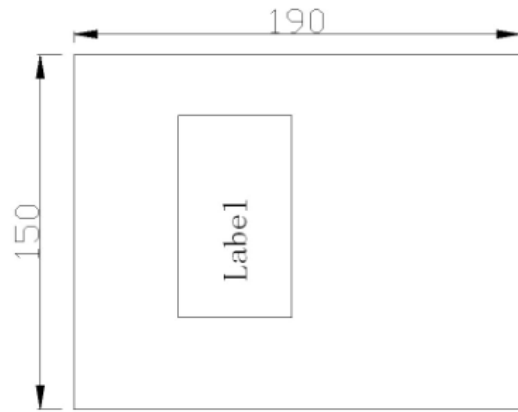

(pcs /)	(/)	(/)
500	10	4