

81106230B v EV



Electrical Optical Characteristics at Ta=25

Parameter	Symbol	Min.	Typ.	Max.	Unit	Test Condition
Radiant Intensity	I _e	6.4	8.8	---	mW/sr	I _F =20mA ^{*1 3}
Viewing Angle	2 _{1/2}	---	58	---	Deg.	I _F =20mA ^{*2}
Peak Wavelength	λ _p	830	850	870	nm	I _F =20mA
Spectral Line Half- Width		---	50	---	nm	I _F =20mA
Forward Voltage	V _F	1.10	1.40	1.60	V	I _F =20mA
Reverse Current	I _R	---	---	10	μA	V _R =5V

Note:

- Point sources of the amount of radiation per unit time in a given direction within the unit solid Angle radiated energy.
- 2_{1/2} is the off-axis angle at which the Radiant Intensity is half the axial Radiant Intensity.
- The I_e guarantee should be added ±15% tolerance.

Typical Electrical / Optical Characteristics Curves (25 Ambient Temperature Unless Otherwise Noted)

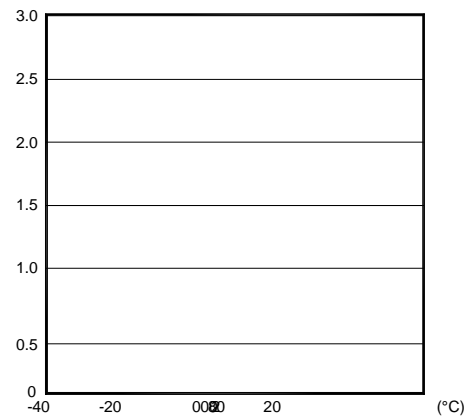
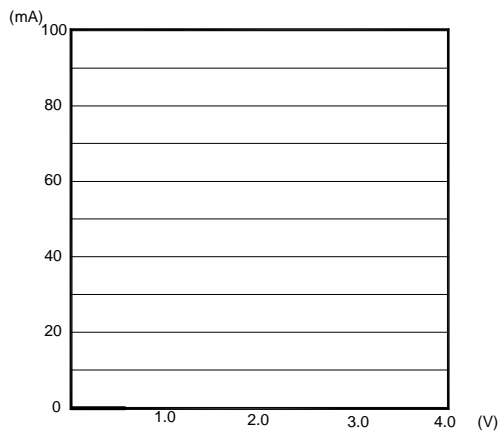



Radiant Intensity Bin Code ($I_F=20\text{mA}$)

BIN CODE	Min. (mW/sr)	Max. (mW/sr)
24	6.4	7.7
25	7.7	9.2
26	9.2	11.0
27	11.0	13.0
...

NOTE: The I_e guarantee should be added $\pm 15\%$ tolerance.

Label Explanation

LIGHT Universal Label
(Reel Label)

LIGHT		
Light Electronics CO., LTD.		
MODEL NAME: _____		LOT NO. : _____
QUANTITY: _____		
BI N: _____		
PACKING DATE: _____		
REMARKS: _____		

Customer Defined Label
(Aluminum Moisture Proof Bag Label)

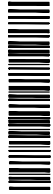
LIGHT		
Light Electronics CO., LTD.		
MODEL NAME: _____		LOT NO. : _____
QUANTITY: _____		
BI N: _____		
PACKING DATE: _____		
CUSTOMER P/N: _____		

Reel Dimensions

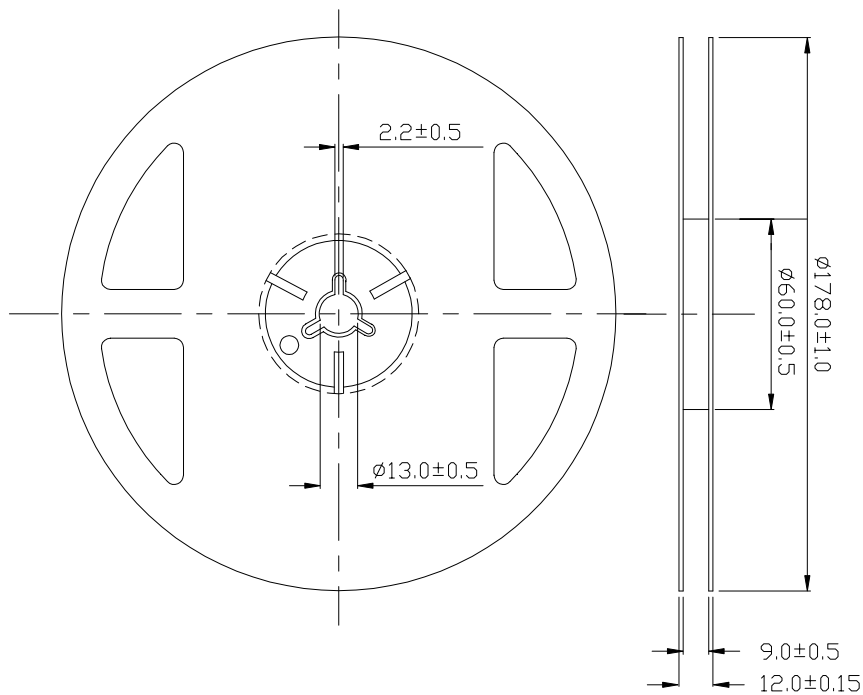

Note: Tolerance unless mentioned is ± 0.2 mm; Unit = mm



Suggest IR Reflow Condition For Lead Free

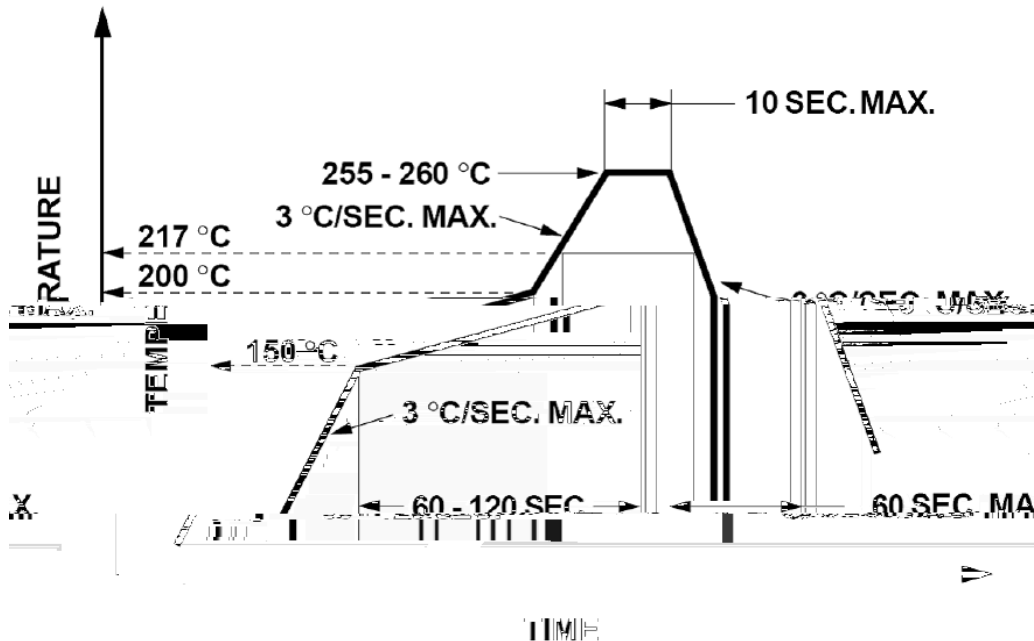

1. Reflow soldering should not be done more than two times.
2. When soldering, do not put stress on the LEDs during heating.

Soldering iron

1. When hand soldering, the temperature of the iron must less than 300 for 3 seconds.
2. The hand solder should be done only once.

Repairing

Repair should not be done after the LEDs have been soldered. When repairing is unavoidable, a double-head soldering iron should be used (as below figure). It should be confirmed beforehand whether the characteristics of LEDs will or will not be damaged by repairing.

