

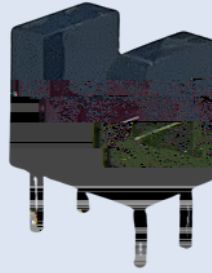

# LG-ITR20403-C



DEVICE NO.	CHIP MATERIAL	LENS COLOR
IR	GaAs	Black
PT	Silicon	Black

## DESCRIPTIONS

The LG-ITR20403-C consist of an infrared emitting diode and a silicon phototransistor, encased side-by-side on converging optical axis in a black thermoplastic housing. The phototransistor receives radiation from the IR LED only. This is the normal situation. But when an object is in between, phototransistor could not receives the radiation.

## APPLICATION

- ★ Mouse Copier
- ★ Switch Scanner
- ★ Floppy disk driver
- ★ Non-contact Switching
- ★ For Direct Board

## FEATURES

- Fast response time
- High analytic
- Cut-off visible wavelength  $\lambda_p=940\text{nm}$
- High sensitivity
- Pb free
- The product itself will remain within RoHS compliant version

## PACKAGE DIMENSIONS

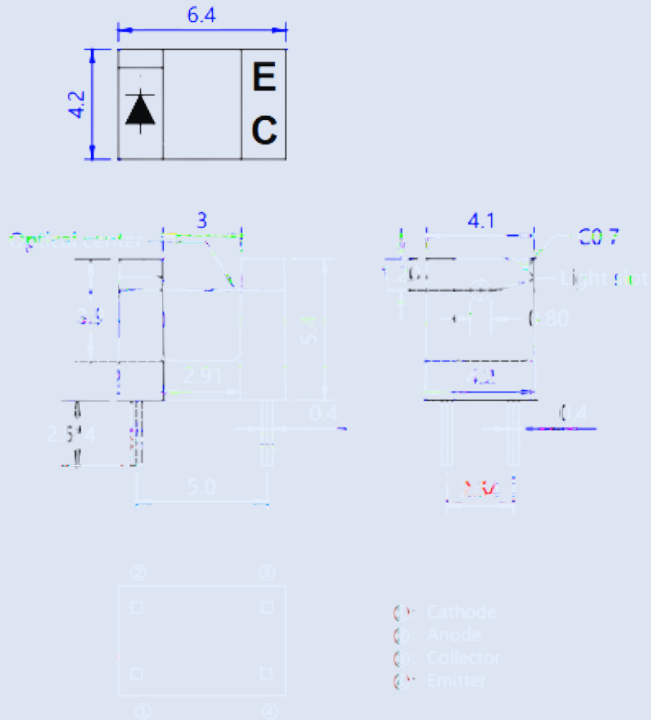

## NOTS

1. All dimensions are in millimeters.
2. Tolerance is  $\pm 0.20\text{mm}$  unless otherwise noted.
3. Lead spacing is measured where the leads emerge from the package.



# LG-ITR2C-502725

ITR9707

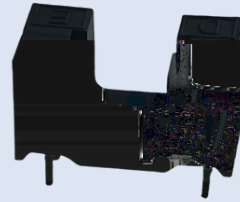
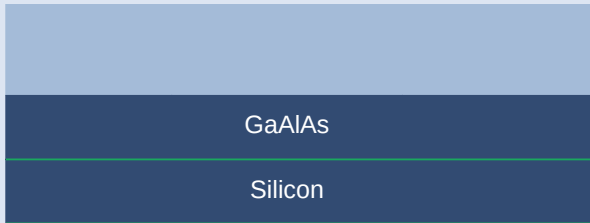

- ★ Mouse Copier
- ★ Switch Scanner
- ★ Floppy disk driver
- ★ Non-contact Switching
- ★ For Direct Board

Fast response time  
High analytic  
Cut-off visible wavelength  
 $\lambda_p=940\text{nm}$   
High sensitivity  
Pb free  
The product itself will remain within  
RoHS compliant version

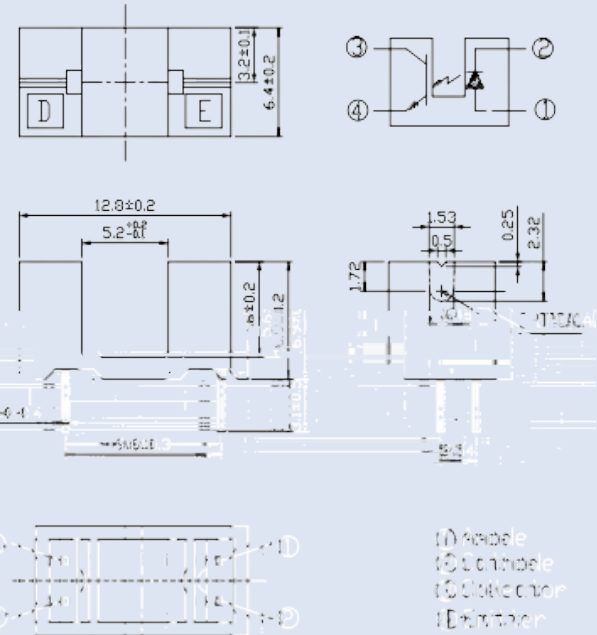

1. All dimensions are in millimeters.
2. Tolerances unless dimensions ±0.2mm.

The LG-ITR2C-502725 consist of an infrared emitting diode and an NPN silicon phototransistor, encased side-by-side on converging optical axis in a black Thermoplastic Housing The phototransistor receives radiation from the IRED only .This is the normal Situation. But when an object is in between , phototransistor could not receives the radiation.

# LG-ITR2C-553924

对标亿光料号ITR9606



DEVICE NO.	CHIP MATERIAL	LENS COLOR
IR	GaAlAs	Water Clear
PT	Silicon	B

## DESCRIPTIONS

G C

ED  
B

## APPLICATION

- ★ C
- ★
- ★F
- ★
- ★F D B

## FEATURES

- F
- C
- λ

## PACKAGE DIMENSIONS

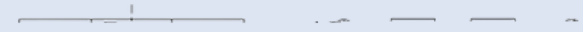

## NOTS

A



对标亿光料号 ITR8402

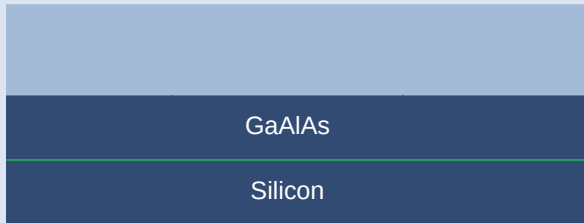

- ★ Mouse Copier
- ★ Switch Scanner
- ★ Floppy disk driver
- ★ Non-contact Switching
- ★ For Direct Board

The LG-ITR2C-554624 consist of an infrared emitting diode and an silicon phototransistor, encased side-by-side on converging optical axis in a black thermoplastic housing, The phototransistor receives radiation from the IR LED only .This is the normal situation. But when an object is in between , phototransistor could not receives the radiation.

Fast response time  
High analytic  
Cut-off visible wavelength  
 $\lambda_p=940\text{nm}$   
High sensitivity  
Pb free  
The product itself will remain within  
RoHS compliant version

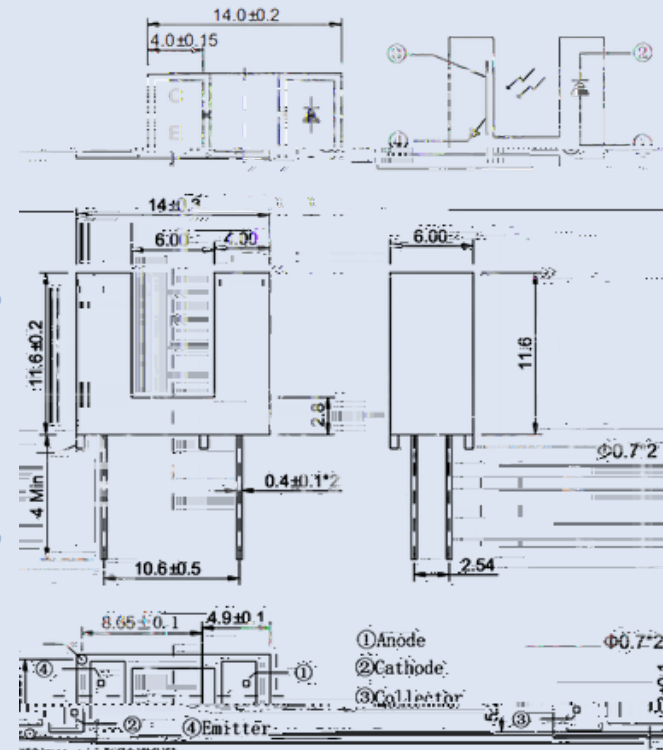

1. All dimensions are in millimeters.
2. Tolerance is ±0.20mm unless otherwise noted.
3. Lead spacing is measured where the leads emerge from the package.

# LT-ITR8307S



DEVICE NO.	CHIP MATERIAL	LENS COLOR
IR	GaAs	/
PT	Silicon	/

## DESCRIPTIONS

LT-ITR8307S is a reflective photoelectric switch that includes a GaAs infrared LED emitter and a highly sensitive NPN phototransistor receiver, suitable for short-range detection and operating in the infrared spectral range. These two components are installed side by side in a plastic package. This photoelectric switch has the characteristics of fast response speed, high sensitivity, strong anti-interference ability, low power consumption, small size, and strong reliability.

## APPLICATION

- ★Camera
- ★Mouse Copier
- ★Switch Scanner
- ★Floppy disk driver
- ★Non-contact Switching
- ★For Direct Board
- ★Various microcomputer control equipment

## FEATURES

- Fast response time
- High sensitivity
- Cut-Off visible wavelength
- Strong anti-interference ability
- Thin
- High reliability
- Compact

## PACKAGE DIMENSIONS

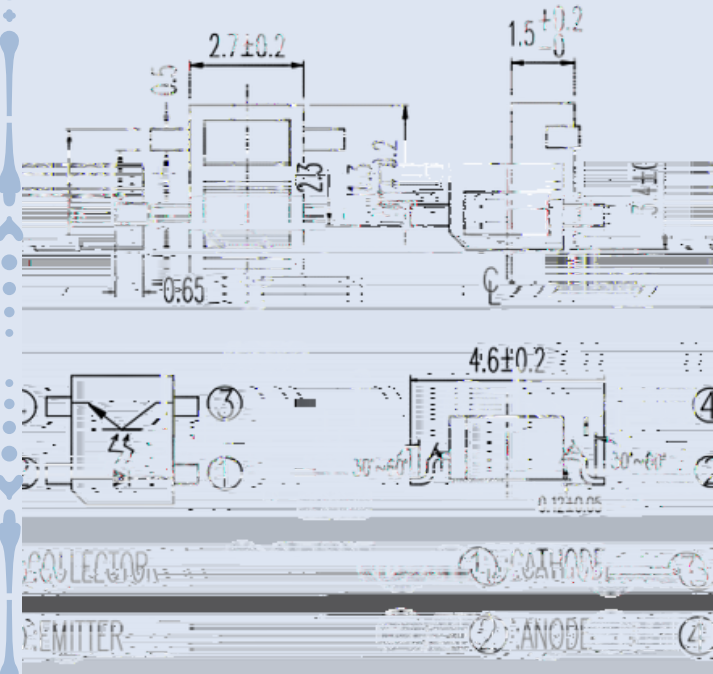

## NOTS

1. All dimensions are in millimeters
2. Tolerances unless dimensions  $\pm 0.15\text{mm}$